

## The causes of cancer

Information on cancer causation has come from investigation of the patterns of cancer in human populations and the induction of tumours in experimental animals following treatment with cancer-causing agents. The most important human carcinogens include tobacco, asbestos, aflatoxins and ultra-violet light. Almost 20% of cancers are associated with chronic infections, the most significant ones being hepatitis viruses (HBV, HCV), papillomaviruses (HPV) and *Helicobacter pylori*. There is increasing recognition of the causative role of lifestyle factors, including diet, physical activity, and alcohol consumption. Genetic susceptibility may significantly alter the risk from environmental exposures.



Detail from Edgard Maxence, *Femme à l'orchidée*, 1900 (RF 1989-41) Paris, musée d'Orsay.

# TOBACCO

## SUMMARY

- > In addition to lung cancer, tobacco consumption causes tumours of the larynx, pancreas, kidney, bladder and, in conjunction with alcohol drinking, a high incidence of carcinomas of the oral cavity and the oesophagus. In most developed countries, tobacco accounts for as much as 30% of all malignant tumours.
- > Lung cancer risk is determined by the amount of daily consumption of tobacco, duration of smoking and the depth of inhalation. For regular smokers, the relative risk for the development of lung cancer is more than 20 times higher than for non-smokers. Environmental tobacco smoke (passive smoking) is also carcinogenic but the risk is much smaller (relative risk 1.15-1.2).
- > Tobacco smoke contains a great number of chemical carcinogens. The pattern of mutations in the *p53* tumour suppressor gene in smoking-associated lung tumours suggests that benzo(a)pyrene metabolites play a major role in the development of lung cancer.
- > Cessation of smoking significantly reduces the risk of lung and other tobacco-associated cancers, even after many years of addiction. However, even ten or more years after stopping smoking, the risk is somewhat greater than that of never-smokers.
- > Tobacco smoking is also the cause of various non-neoplastic ailments, including cardiovascular and obstructive lung diseases. The life expectancy of regular smokers is six to eight years less than that of people who have never smoked.

Use of tobacco has been identified by WHO as the major preventable cause of death of humankind. The topic is addressed here only in relation to cancer,

although tobacco smoking causes a range of cardiovascular and respiratory diseases [1]. Tobacco smoking causes cancer of the lung and other organs and is the most intensively investigated environmental cause of cancer. Most information available involves the burden of smoking-related disease in more developed countries; far less is known in relation to less developed countries, though predictions can be made with confidence.

## Preparation and use of tobacco

The main tobacco plant in the world is *Nicotiana tabacum*, although some varieties of *N. rustica* are also cultivated and used. Tobacco was imported from North America to Europe, Asia and Africa in the second half of the 16th century. By the mid-17th century, tobacco was being grown for commercial purposes not only in the American colonies, but also in Europe and East Asia. Industrial production of cigarettes started in the second half of the 19th century.

Tobacco needs to be cured before consumption. Two main curing processes are used. In flue-curing, the ripe leaves are cut and dried by artificial heat. Common names of flue-cured tobacco include “blond” and “Virginia”. In air-curing, the entire plant is harvested and no artificial heat is used. Air-cured tobacco includes “Maryland” and “black”. Cigars are also made of air-cured tobacco. Less important methods include sun-curing, fire-curing and various local adaptations. For “oriental” tobacco, sun- and air-curing are combined.

Cigarettes represent the most important tobacco product worldwide [2]. They are made from fine-cut tobacco wrapped in paper or maize leaf. The weight is between 0.5 and 1.2 g. Tobacco may be sprayed with sugar and other flavouring or aromatic agents. Other smoking tobacco products include cigars and cigarillos (which vary greatly in size, weight and flavour and have many local names, e.g. cheroots, chuttas, stumpen), tobacco for pipes and

water pipes, bidis (flaked tobacco rolled in a piece of dried temburni leaf), as well as many other local products. Tobacco is also chewed, alone or with lime, betel nut or other compounds [3]. The habit is prevalent in the Indian region and South America, but also in North America and Northern Europe.

Tobacco snuff is taken in many countries, notably in Scandinavia, India and neighbouring countries, the Mediterranean and Southern Africa. The composition of chewing tobacco and snuff greatly varies geographically. In addition, other smokeless products are used in various parts of the world (e.g. “nass”, a mixture of tobacco, lime, ash, and other ingredients, in Central Asia).

World production of tobacco is approximately seven million tonnes annually, China accounting for almost a third of this total [4]. Global trade in tobacco represents a major economic enterprise; although the USA and Europe lead the field, India and various nations of Africa are also major exporters (Table 2.1).

## Exposure

The people most immediately exposed to the products of tobacco combustion are the



Fig. 2.1 Tobacco market in Zimbabwe. In the developing world, tobacco consumption is increasing rapidly.

users, that is, active smokers. The prevalence of smoking varies throughout the world and is subject to change (Fig. 2.8). The proportion of smokers is decreasing among men in industrialized countries. More than

70% of men born in Europe and North America during the first decades of the 20th century smoked during some time of their life, but this proportion has decreased in more recent times. There is an increasing

proportion of ex-smokers in many countries, particularly within older age groups.

A different pattern is seen in women. In contrast to male smoking rates, smoking by women only became prevalent in the second half of the 20th century. While in some countries, such as the United Kingdom, the proportion of women who smoke has started to decrease in recent years, in most industrialized countries this proportion is still increasing [4].

In developing countries, less comprehensive data are available. It is clear, however, that a great increase in smoking has taken place during the last decade in many countries. The increase is particularly dramatic in China, where more than 60% of adult men are estimated to smoke, representing almost one-third of the total number of smokers worldwide. The prevalence of smoking among women in most developing countries is still low, although in many countries young women are taking up the habit. In India and its neighbouring countries, smokeless tobacco is widely used and “bidi” smoking is also common, this being the cheapest form of smoking available.

Non-smokers are exposed to environmental tobacco smoke, the extent of exposure being determined primarily by whether family members smoke and by workplace conditions. The amount of tobacco smoke inhaled as a consequence of atmospheric pollution is much less than that inhaled by an active smokers [5].

### Cancer risk

Tobacco smoking is the main known cause of human cancer-related death worldwide. Smoking most commonly causes lung cancer [6]. For a smoker, lung cancer risk is related to the parameters of tobacco smoking in accordance with the basic principles of chemical carcinogenesis: risk is determined by the dose of carcinogen, the duration of administration and the intensity of exposure. In respect of these determinants of lung cancer risk, women are at least as susceptible as men. An increase in risk of lung cancer (relative to a non-smoker) is consistently evident at the lowest level of daily consumption, and is at least linearly related to increasing

Location	Production (tonnes/annum)	Import (tonnes)	Export (tonnes)
USA	890,240	234,910	266,104
Europe	760,086	772,675	319,568
Russia	290,000	86,000	2,200
Africa	274,624	85,989	187,208
China	2,000,000	80,000	10,000
India	525,000	100	104,862
Global	6,660,000	1,512,638	1,484,144

Table 2.1 Tobacco production, imports and exports. In some regions, such as Africa and India, the export of tobacco is a major source of income.



Fig. 2.2 Magazine advertising in the 1970s directed towards women in the USA.



Fig. 2.3 Smoking by children is increasing world-wide.



Fig. 2.4 A young man smoking a hookah (Bangladesh).

consumption (Fig. 2.6). The risk is also proportional to the duration of smoking. Hence, the annual death rate from lung cancer among 55-64 year-olds who smoked 21-39 cigarettes daily is about three times higher for those who started smoking at age 15 than for those who started at age 25.

Intensity of exposure to tobacco smoke is determined by the smoking device used (cigarette, cigar, pipe, hookah, etc.) and, for any one method, may be determined by the “depth” of inhalation. Smoking of black tobacco cigarettes represents a greater risk for most tobacco-related cancers than smoking of blond cigarettes. Similarly, filtered and low-tar cigarettes entail a lower risk for most tobacco-related cancers than unfiltered and high-tar cigarettes. However, a “safe” cigarette does not exist; all smoking tobacco products entail a carcinogenic risk. Taken together, the epidemiological data summarized above establish “causation” because of the consistency of results, the strength of the relationship, its specificity, the temporal sequence between exposure and disease and the dose-response relationship.

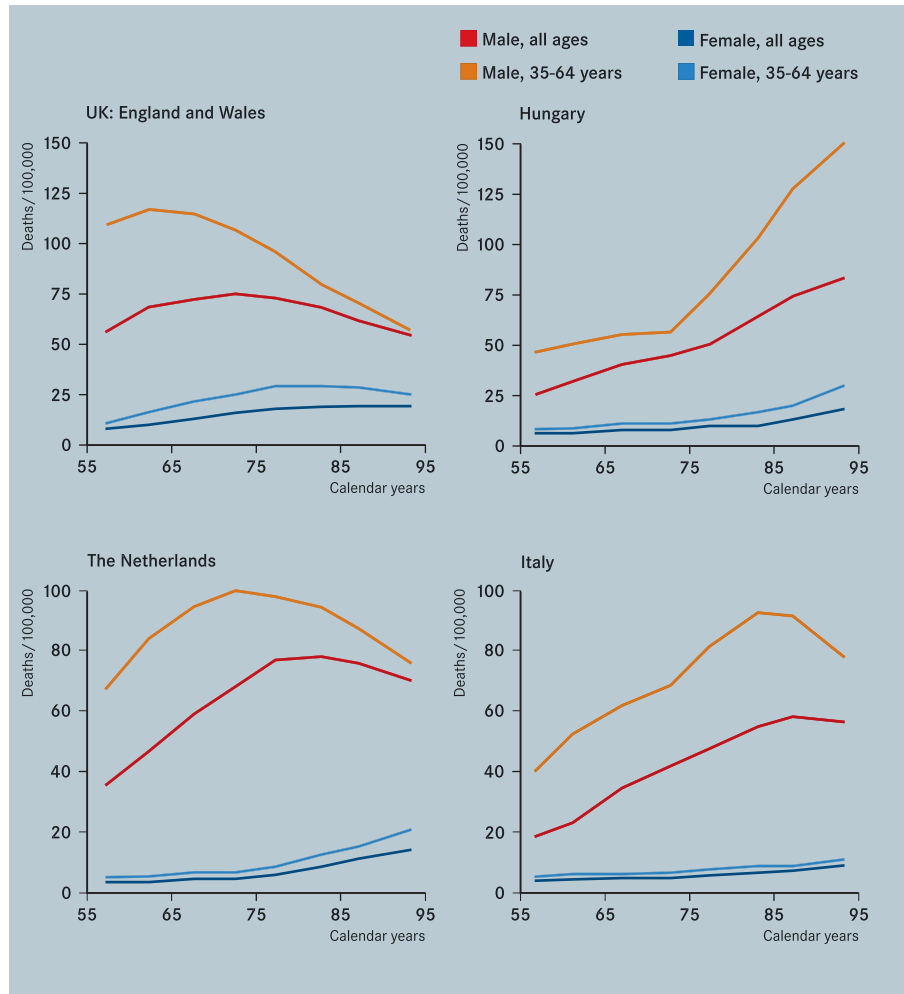

Fig. 2.5 Mortality due to lung cancer is decreasing in men in most industrialized countries, an exception being Hungary, which now has the highest rates of lung cancer mortality in the world.

Within many communities, smoking, and hence lung cancer, are sharply related to social class [7]. Between communities worldwide, incidence of lung cancer varies dramatically. High rates are observed in parts of North America, while developing countries have the lowest rates (Fig. 2.7). In the USA, Europe and Japan, 83-92% of lung cancer in men and 57-80% of lung cancer in women is tobacco-related. A maximal impact of lung cancer occurs when the population has attained a maximal prevalence of smoking that has continued throughout most of the life span of the smokers. As the prevalence of smoking increases, it is likely that an epidemic of

lung cancer will sweep the developing world in the coming decades [8]. In addition to lung cancer, smoking causes cancers of the larynx, oral cavity, pharynx, oesophagus, pancreas, kidney and bladder [2] (Table 2.3). Dose-response relationships between number of cigarettes smoked and risks for developing these cancers have been found consistently. Most data involve cigarette smoking but, for example, cigar and pipe smoking present a greater risk for cancer of the oral cavity than does cigarette smoking. For cancer of the bladder and kidney, risks vary with the duration and intensity of smoking, but are lower than those for lung cancer. In non-alcohol drink-



Substances	Tobacco smoke (per cigarette)	Smokeless tobacco (ng/g)
<b>Volatile aldehydes</b>		
Formaldehyde	20-105 µg	2,200-7,400
Acetaldehyde	18-1,400 µg	1,400-27,400
Crotonaldehyde	10-20 µg	200-2,400
<b>N-Nitrosamines</b>		
N-Nitrosodimethylamine	0.1-180 ng	0-220
N-Nitrosodiethylamine	0-36 ng	40-6,800
N-Nitropyrolidine	1.5-110 ng	0-337
<b>Tobacco-specific nitrosamines</b>		
N'-Nitrosonornicotine (NNN)	3-3,700 ng	400-154,000
4-(Methylnitrosamino)-1-(3-pyridyl)-1-butanone (NNK)	0-770 ng	0-13,600
4-(Methylnitrosamino)-1-(3-pyridyl)-1-butanol (NNAL)	+	+
N'-Nitrosoanabasine (NAB)	14-46 ng	0-560
<b>Metals</b>		
Nickel	0-600 ng	180-2,700
Cadmium	41-62 ng	700-790
Polonium 210	1-10 mBq	0.3-0.64 pci/g
Uranium 235 and 238	-	2.4-19.1 pci/g
Arsenic	40-120 ng	
<b>Polycyclic aromatic hydrocarbons</b>		
Benzo[a]pyrene	20-40 ng	>0.1-90
Benzo[a]anthracene	20-70 ng	-
Benzo[b]fluoranthene	4-22 ng	-
Chrysene	40-60 ng	-
Dibenzo[a,l]pyrene	1.7-3.2 ng	-
Dibenzo[a,h]anthracene	+	-

Table 2.2 Carcinogenic agents in tobacco smoke and smokeless tobacco. + = present, - = absent

ing male smokers, risk of developing cancer of the oral cavity is about double that for non-drinking non-smokers. Elevations of ten-fold or more are evident for cancer of the larynx and five-fold or more for oesophageal cancer. The proportion of these cancers attributable to smoking varies with the tumour site and across communities, but is consistently high (80% or more) for laryngeal cancer specifically. A common feature of lung and other smoking-induced cancers is the pattern of decreased risk which follows smoking cessation (“quitting”) relative to continuing smoking [2]. The relative risk of cancer at most sites is markedly lower than that of

current smokers after five years’ cessation, although risks for bladder cancer and adenocarcinoma of the kidney appear to persist for longer before falling. Despite the clearly established benefit of cessation, the risk for ex-smokers does not decrease to that for “never smokers”. Overall, decreased risk of lung and other cancers consequent upon quitting is further evidence (if any were needed) that smoking is causes the diseases in question (*Tobacco control*, p128). Other cancer types may be a consequence of smoking [9]. These include cancer of the stomach, liver, nose and myeloid leukaemia. In contrast, some of

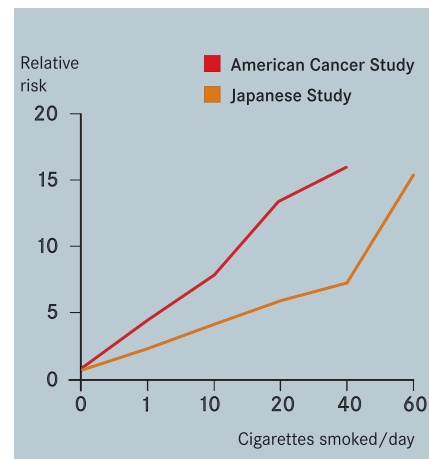

Fig. 2.6 Risk of lung cancer is determined by number of cigarettes smoked.

the increased incidence of bowel and cervical cancer in smokers may be due to confounding. Exposure to environmental tobacco smoke causes lung cancer and possibly laryngeal cancer, although the burden of disease is much less than in active smokers; the relative risk has been estimated at about 1.15-1.2. Association of increased risk of breast cancer with exposure to environmental tobacco smoke is controversial [5]. Tobacco smoking has been estimated to cause approximately 25% of all cancers in men and 4% in women, and, in both genders, approximately 16% of cancer in more developed countries and 10% in less developed countries [11], although some estimates are as high as 30% [12]. The low attributable risk in women (and, to a lesser extent, in developing countries) is due to the low consumption of tobacco in past decades. A recent upward trend in smoking prevalence among women in many developing countries will result in a much greater number of attributable cancers in the future. Use of smokeless tobacco products has been associated with increased risk of head and neck cancer [10]. Since chewing of tobacco-containing products is particularly prevalent in Southern Asia, it represents a major carcinogenic hazard in that region.

Cancers positively associated with smoking	Sex	Standardized mortality per 100,000/year		Relative risk	Absolute excess risk per 100,000/year	Attributable proportion (%)*
		Life-long non-smoker	Current cigarette smoker			
Lung cancer	M	24	537	22.4	513	87
	F	18	213	11.9	195	77
Cancer of the upper respiratory sites	M	1	27	24.5	26	89
	F	2	10	5.6	8	58
Cancer of the bladder and other urinary organs	M	18	53	2.9	35	36
	F	8	21	2.6	13	32
Pancreatic cancer	M	18	38	2.1	20	25
	F	16	37	2.3	21	29
Oesophageal cancer	M	9	68	7.6	59	66
	F	4	41	10.3	37	74
Kidney cancer	M	8	23	3	15	37
	F	6	8	1.4	2	11

American Cancer Study. Men and women aged 35 yrs and more. \*Attributable proportion is the proportion of all deaths from the specified disease which are attributable to cancer, assuming that 30% of the population are current smokers and that all the excess risk in smokers is due to smoking.

Table 2.3 Smoking increases the risk of many human cancers.

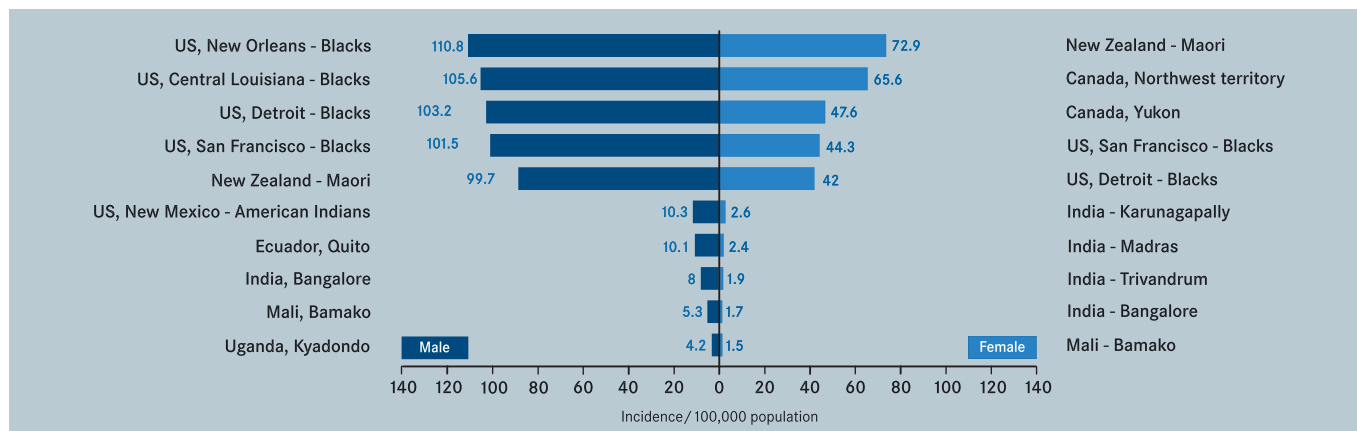

Fig. 2.7 The five highest and the five lowest recorded lung cancer incidence rates in males and females.

### Interaction with other hazards

Alcohol consumption, exposure to asbestos and exposure to ionizing radiation interact with smoking in determining risk of some cancers [13]. For alcohol drinking and smoking, risks for cancer of the larynx, oesophagus and oral cavity increase multiplicatively in relation to the respective risks generated by either expo-

sure in the absence of the other. For individuals exposed to both asbestos and tobacco smoke (for example, insulation workers who smoke), risk of lung cancer is also increased multiplicatively, although smoking does not affect risk of mesothelioma (a tumour type specifically caused by asbestos). Quitting smoking can considerably lower the risk for lung cancer

among people who were exposed to asbestos in the past.

### Mechanisms of carcinogenesis

As tobacco is the most important human carcinogen, elucidation of mechanisms which result in cancer among humans exposed to tobacco smoke provides an important means for assessing some pre-

ventive options, and may be relevant to the prevention of other environmentally-induced cancer.

Mainstream smoke (the material inhaled by smokers) is an aerosol including approximately 4,000 specific chemicals and containing  $10^{10}$  particles per ml. The particulate matter (tar) is made up of some 3,500 compounds, the most abundant being nicotine (0.1-2.0 mg per cigarette) and also including most of the polycyclic aromatic hydrocarbons occurring in the smoke [14]. Another class of carcinogens represented in tobacco smoke is *N*-nitroso compounds, particularly including the nitroso derivatives of nicotine and nornicotine [15]. Chemicals such as aromatic amines, benzene and heavy metals, independently established as carcinogenic for humans, are present in tobacco smoke (Table 2.2). Use of smokeless tobacco results in exposure to tobacco-related nitroso compounds, but not to polycyclic aromatic hydrocarbons, which are products of combustion.

Cancer causation by tobacco smoke is not attributable to any one chemical component, or any one class of chemicals present, but to an overall effect of the complex mixture of chemicals in smoke. Mechanistic inferences which can be made from epidemiological studies, together with relevant experimental data, indicate a scenario compatible with “multistage carcinogenesis” as understood at the cellular and molecular level (*Multistage carcinogenesis*, p84) [16]. Epidemiological studies indicate that for cancers of the lung, bladder and head and neck (data for other cancers are inadequate for such evaluation), the various carcinogens in tobacco smoke exert an effect on both early and late steps in the process of carcinogenesis. Evidence for early effects comes from the higher risk associated with early age at starting smoking and with increasing time since beginning smoking, while the continued elevated risk, albeit at decreasing levels over time, following quitting smoking is a strong argument for late effects.

Most chemical carcinogens in tobacco smoke require metabolic activation in order to exert a carcinogenic effect [17].

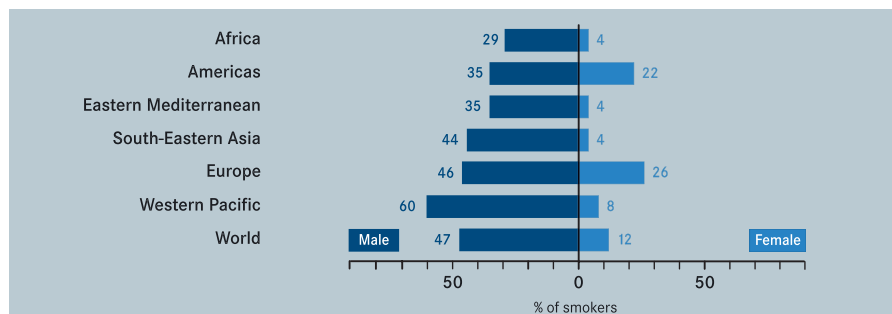

Fig. 2.8 Estimated prevalence of smoking among adults by region, in the early 1990s.

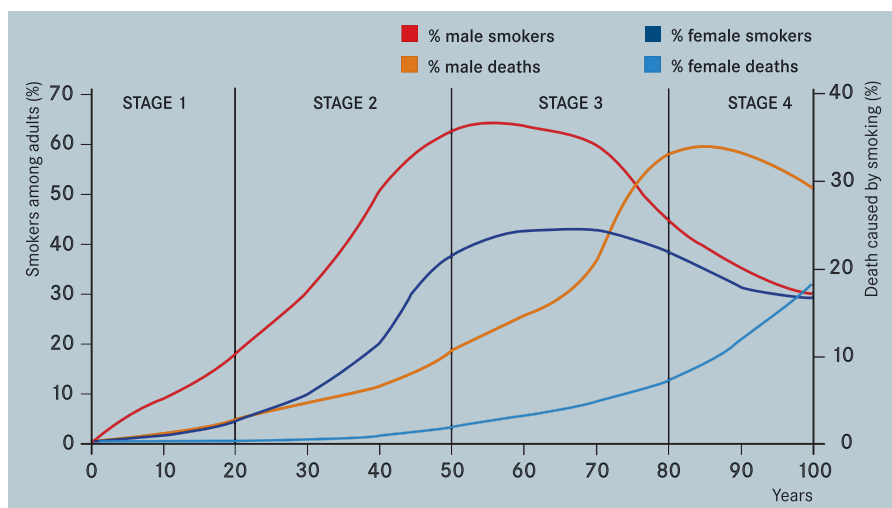

Fig. 2.9 A model describing stages of the tobacco epidemic based on data from developed countries. Note the time lag between increase in consumption and the manifestation of lung cancer

The requisite enzymes are present in lung and other “target” organs. Individual risk may be affected by the activity and levels of enzymes such as glutathione-*S*-transferase, cytochrome P450 and *N*-acetyl transferases. In the course of metabolism, reactive forms of polycyclic aromatic hydrocarbons, nitrosamines and aromatic amines are generated and become covalently bound to DNA in relevant tissues. Such DNA adducts, and the products of their repair, have been detected in tissues, bodily fluids and urine from smokers and from persons exposed to environmental tobacco smoke.

The molecular genetics of tobacco smoke-induced lung and other cancers are being progressively elucidated. An increasing number of genes are implicated as being

relevant to a carcinogenic outcome [18]. The degree of current understanding is exemplified by studies of the pattern of mutation in the *p53* gene. When comparison is made of particular mutation frequencies in lung cancers from smokers and non-smokers, differences are evident. Using relevant experimental systems, mutations evident in smokers are attributable, at least in part, to the miscoding caused by the binding of some polycyclic aromatic hydrocarbons to DNA [19].

## PHARMACOLOGICAL APPROACHES TO SMOKING ADDICTION

Quitting smoking is very difficult. Surveys show that 74% of smokers report a desire to quit and 70% of smokers have made previous attempts to quit smoking, yet success rates remain low (US Department of Health and Human Services, *Healthy People 2000 Review*, 1994). The difficulty that most smokers encounter reflects both a habit and a physiological addiction. In addition, cessation involves discontinuing a dependency that smokers acquired at a vulnerable period in their lives (*Tobacco control*, p128).

The low success rates associated with unaided attempts to quit suggest that

pharmacological treatment be offered unless there is a medical contraindication. Treatments for smoking addiction include nicotine replacement therapies and non-nicotine therapy (Okuyemi KS et al., *Arch Family Med*, 9: 270-281, 2000; The Tobacco Use and Dependence Clinical Practice Guideline Panel, *JAMA*, 283: 3244-3254, 2000). Nicotine replacement therapies include nicotine polacrilex gum, transdermal nicotine patch, nicotine nasal spray, nicotine sublingual tablet, and nicotine inhaler but only about 25% of attempts involve the use of any nicotine replacement therapy.

The only approved non-nicotine therapy is the antidepressant bupropion hydrochloride. Other antidepressants such as nortriptyline and moclobemide have shown

some promise but are not generally approved for use.

Combination of two nicotine replacement therapies (patch plus gum, spray, or inhaler) or a nicotine replacement therapy plus a non-nicotine drug (bupropion) may work better than single agents.

In summary, treatments help fewer than one in five smokers and are not being used by the majority of smokers trying to quit. Recent progress in the understanding of the neuropharmacological basis of nicotine addiction holds promise for the development of new treatments.

## REFERENCES

1. Wald NJ, Hackshaw AK (1996) Cigarette smoking: an epidemiological overview. *Br Med Bull*, 52: 3-11.
2. IARC (1986) *Tobacco Smoking (IARC Monographs on the Evaluation of the Carcinogenic Risk of Chemicals to Humans, Vol. 38)*, Lyon, IARC Press.
3. IARC (1985) *Tobacco Habits Other Than Smoking; Betel-quid and Areca-nut Chewing; and Some Related Nitrosamines (IARC Monographs on the Evaluation of Carcinogenic Risks to Humans, Vol. 37)*, Lyon, IARC Press.
4. Corrao MA, Guindon GE, Sharma N, Shokooi DF, eds (2000) *Tobacco Control Country Profiles*, Atlanta, Georgia, American Cancer Society.
5. Law MR, Hackshaw AK (1996) Environmental tobacco smoke. *Br Med Bull*, 52: 22-34.
6. Boyle P, Maisonneuve P (1995) Lung cancer and tobacco smoking. *Lung Cancer*, 12: 167-181.
7. Stellman SD, Resnicow K (1997) Tobacco smoking, cancer and social class. In: Kogevinas M, Pearce N, Susser M & Boffetta P, eds, *Social Inequalities and Cancer, (IARC Scientific Publications, No. 138)*, Lyon, IARC Press, 229-250.
8. Chen ZM, Xu Z, Collins R, Li WX, Peto R (1997) Early health effects of the emerging tobacco epidemic in China. A 16-year prospective study. *JAMA*, 278: 1500-1504.
9. Doll R (1996) Cancers weakly related to smoking. *Br Med Bull*, 52: 35-49.
10. Winn DM (1997) Epidemiology of cancer and other systemic effects associated with the use of smokeless tobacco. *Adv Dent Res*, 11: 313-321.

11. Parkin DM, Pisani P, Lopez AD, Masuyer E (1994) At least one in seven cases of cancer is caused by smoking. Global estimates for 1985. *Int J Cancer*, 59: 494-504.
12. Doll R, Peto R (1981) The causes of cancer: quantitative estimates of avoidable risk of cancer in the USA today. *J Natl Cancer Inst*, 66: 1191-1308.
13. Levi F (1999) Cancer prevention: epidemiology and perspectives. *Eur J Cancer*, 35: 1912-1924.
14. Rodgman A, Smith CJ, Perfetti TA (2000) The composition of cigarette smoke: a retrospective, with emphasis on polycyclic components. *Hum Exp Toxicol*, 19: 573-595.
15. Brunnemann KD, Prokopczyk B, Djordjevic MV, Hoffmann D (1996) Formation and analysis of tobacco-specific N-nitrosamines. *Crit Rev Toxicol*, 26: 121-137.
16. Shields PG (2000) Epidemiology of tobacco carcinogenesis. *Curr Oncol Rep*, 2: 257-262.
17. Hecht SS (1999) Tobacco smoke carcinogens and lung cancer. *J Natl Cancer Inst*, 91: 1194-1210.
18. Shields PG, Harris CC (2000) Cancer risk and low-penetrance susceptibility genes in gene-environment interactions. *J Clin Oncol*, 18: 2309-2315.
19. Hainaut P, Hollstein M (2000) p53 and human cancer: the first ten thousand mutations. *Adv Cancer Res*, 77: 81-137.
20. IARC (2003) *Tobacco Smoke and Involuntary Smoking (IARC Monographs on the Evaluation of Carcinogenic Risks to Humans, Vol. 83)*, Lyon, IARC Press. *In preparation*.

## WEBSITES

- Tobacco & Cancer, The American Cancer Society: [http://www.cancer.org/docroot/PED/ped\\_10.asp?sitearea=PED](http://www.cancer.org/docroot/PED/ped_10.asp?sitearea=PED)
- Tobaccopedia, an online tobacco encyclopaedia: <http://tobaccopedia.org/>



# ALCOHOL DRINKING

## SUMMARY

- > Heavy alcohol drinking causes cancer of the oral cavity, pharynx, larynx, oesophagus, and liver, and may increase the risk of breast and colorectal cancer.
- > Risk is linearly related to the mean daily consumption.
- > Low levels of consumption appear to exert a protective effect against cardiovascular disease.
- > In the oral cavity, pharynx, larynx and oesophagus, the risk is greatly increased by concurrent smoking.

Beverages containing alcohol (the common name for ethanol) as the product of the fermentation of carbohydrates have been produced in most human societies since ancient times. Despite great variety, most alcoholic beverages can be grouped as either beers (brewed by fermenting malted barley and typically containing 5% volume of alcohol), wines (made by fermenting grape juice or crushed grapes, containing 12% alcohol) or spirits (made by distilling fermented products of a variety of cereals, vegetables and fruits, containing 40% alcohol). Beverages that are less common and which are often limited to particular regions include cider, fortified wines and flavoured wines. On a global scale, the consumption of alcoholic beverages by adults as calculated from official figures is equivalent to 4 L of alcohol per year (or 9 g/day), corresponding to approximately 3% of the average total intake of calories [1]. Unofficial consumption, however, is estimated to account for an additional amount corresponding to 20-100% of the official figures, depending on the country. Most "unofficial" alcohol is either sold illegally

on the black market (usually to avoid taxation) or produced for private consumption. There is strong regional variability in consumption levels, with a minimum (<1 L/year) in Western and Southern Asia and Northern Africa and maximum (>12 L/year) in Central and Southern Europe. The distribution between each major type of beverage is also country-specific (Fig. 2.10). Official figures show a decrease in alcohol consumption in more developed countries and, over recent years, an increase in consumption in less developed countries.

## Cancers caused

Through analytical epidemiological studies of cohort and case-control type conducted in many populations with different levels of consumption, the causal association of drinking alcohol has been definitely established in respect of oral, oesophageal, liver and other cancers [2]. In particular, studies of cancer risk in brewery workers and in alcoholic patients have provided important evidence on the carcinogenic role of alcohol. A causal association is also established in the case of breast cancer and is probable for colon and rectal cancer [2,3]. There have been suggestions of a possible carcinogenic effect of alcohol drinking on other organs,

such as the lung, but the evidence is still inconclusive [4]. An association between alcohol intake and risk of head and neck cancer is indicated by the geographical pattern of these neoplasms; countries (and regions within countries) with heavy alcohol consumption are among those with the highest incidence of these neoplasms.

For all cancers caused by drinking alcohol, the risk of cancer is a linear function of the level of consumption, up to an intake of about 80 g/day (one litre of wine, a quarter of a litre of spirits), above which

Mean alcohol consumption	Relative risk (95% confidence)
No alcohol	1
> 0 to 30 g/day	1.2 (0.4–3.4)
> 30 to 60 g/day	3.2 (1.0–10.1)
> 60 g/day	9.2 (2.8–31.0)

\*Adjusted for follow-up time, sex, education, body mass index (BMI), vegetable and fruit consumption, tobacco smoking and energy intake

Table 2.4 Consumption of alcohol increases the risk of cancer of the upper gastrointestinal tract.

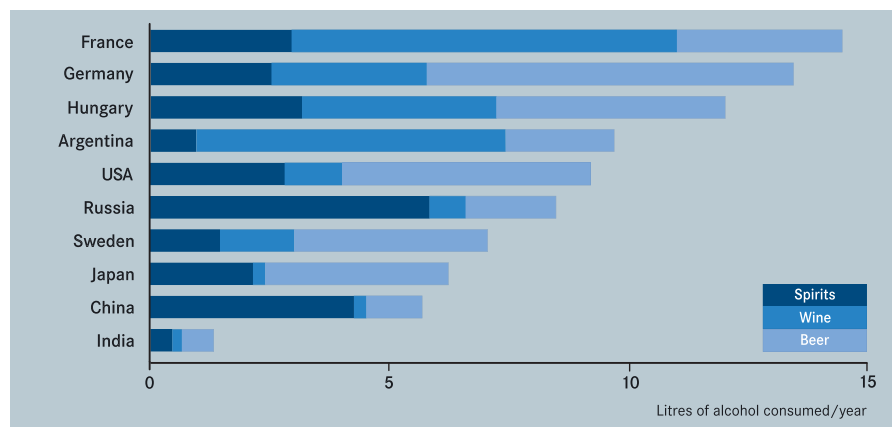

Fig. 2.10 Patterns of alcohol drinking, expressed as mean equivalent volumes of pure ethanol, in selected countries, 1996.

level the dose–response relationship is less clearly defined. The magnitude of increased risk associated with a particular rate of alcohol consumption varies for each tumour type. The risk of head and neck cancer is 5–10 times higher in heavy drinkers than in abstainers, the carcinogenic effect of alcohol appearing to be more potent in the oral cavity, pharynx and oesophagus and weaker in the larynx. The relative risk of breast cancer in women with a high consumption of alcohol is approximately two-fold.

Most available data concerning the carcinogenic role of alcohol in humans are derived from epidemiological studies

based on interviews or similar approaches. Since alcohol drinking carries a strong social stigma in many populations, it is likely that individuals underestimate and under-report their intake of alcohol, particularly in the case of heavy consumption. Under-reporting of alcohol drinking, resulting in the classification of heavy drinkers as light- or non-drinkers, would result in underestimation of the actual carcinogenic effect of the habit. It is possible therefore that the role of alcohol in human cancer is greater than commonly perceived.

Alcohol drinking and tobacco smoking show a synergistic interaction in the etiol-

ogy of cancers of the oral cavity, pharynx, larynx and oesophagus; the risk of cancer for heavy consumers of both products relative to that for subjects who neither smoke nor drink is higher than the product of the risks attributable respectively to heavy drinking and heavy smoking separately (Fig. 2.14) [5]. Very heavy drinkers (e.g. alcoholics), among whom alcohol can be the source of up to 30% of total calorie intake, tend to have a diet poor in fruit and vegetables, which may further enhance their risk of developing these cancers. Relatively few studies have examined possible variations in risk attributable to different alcoholic beverages: evidence on

Region	% of deaths	Years of life lost	Disability-adjusted years life lost
Latin America	4.5	5.9	9.7
Sub-Saharan Africa	2.1	2.0	2.6
Other Asian countries	1.8	1.6	2.8
Former socialist countries	1.4	5.7	8.3
China	1.3	1.8	2.3
Industrialized countries	1.2	5.1	10.3
India	1.2	1.4	1.6
Middle East	0.1	0.2	0.4
Overall	1.5	2.1	3.5

Table 2.5 Percentage of the population dying from alcohol-associated diseases in different world regions, and the respective years of life lost .

Cancer	Men		Women	
	%	No. of cases	%	No. of cases
Oral cavity & pharynx	23	51,000	15	12,700
Oesophagus	24	51,800	14	14,500
Liver	10	30,100	6	7,300
Larynx	22	26,500	14	2,500
Breast	-	-	3	26,800
Total	4	159,400	2	63,800

Table 2.6 Percentage and number of cancer cases worldwide attributable to alcohol consumption, 1990.

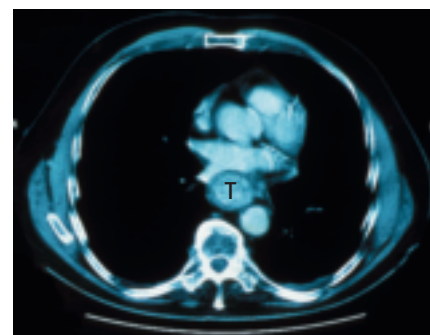

Fig. 2.11 Computed tomography (CT) scan of an oesophageal tumour (T). Heavy alcohol drinking is a major risk factor.

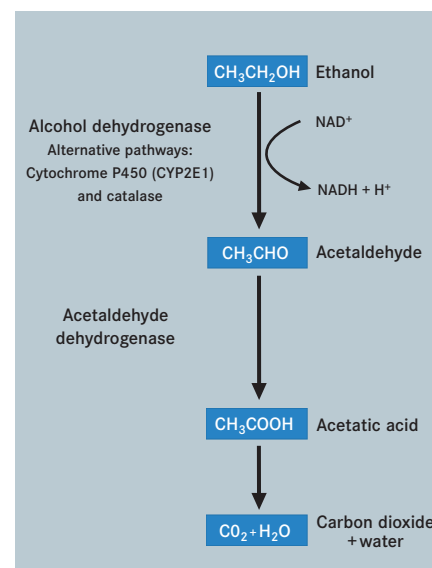

Fig. 2.12 The major pathway of alcohol metabolism in humans.



Fig. 2.13 Some advertising of alcohol (such as this poster from Malaysia) is directed specifically towards women. The liquor concerned is advertised as containing herbs traditionally taken by Chinese women after delivery of their baby. D. Jernigan

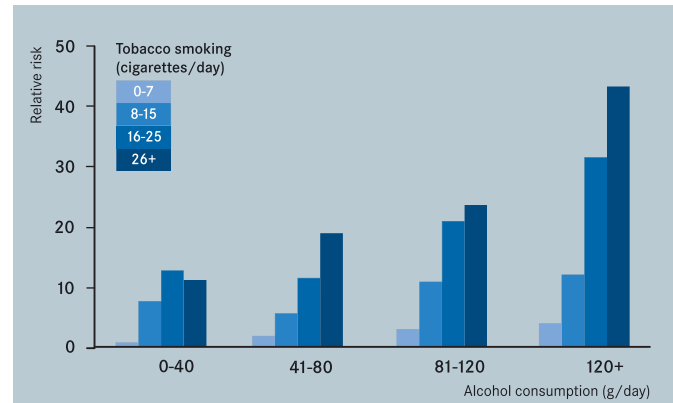

Fig. 2.14 Multiplicative increase in relative risk of laryngeal cancer as a consequence of both alcohol drinking and active smoking (colour coding approximates progressive doubling of risk as exposure increases). A.J. Tuyns et al. (1988) *Int J Cancer*, 41:483-91.

this issue is inconclusive at present. Similarly, there is no clear evidence as to whether the key factor in alcohol carcinogenesis is level of alcohol intake, or whether the pattern of drinking (e.g. regular intake of moderate quantities, typically at meals, versus intermittent intake of large quantities (“binge drinking”) also plays a role.

Alcohol drinking is estimated to be involved in the etiology of 3% of all cancers (that is, 4% in men, 2% in women, Table 2.6). In women, approximately half of the neoplasms attributed to alcohol drinking are breast cancers. However, the actual burden of cancers attributable to alcohol consumption may be greater than these estimates, given that alcohol drinking may be a causative factor in cancers other than those presented, as well as the likely underestimation of the risk.

#### Mechanism of carcinogenesis and relevant model systems

The mechanism(s) of cancer causation by alcoholic beverages is not known. Ethanol has not been established as being carcinogenic to experimental animals. The compound does not appear to react with DNA in mammalian tissue. Among hypotheses proposed to explain the increased cancer risk are (i) a carcinogenic effect of chemicals other than ethanol present in alcoholic beverages (such as *N*-nitrosamines); (ii) a solvent

action which facilitates absorption of other carcinogens (e.g. those in tobacco smoke); (iii) a carcinogenic role for acetaldehyde, the major metabolite of ethanol (Fig. 2.12). This last hypothesis is supported by evidence that acetaldehyde is carcinogenic in experimental animals, as well as by results of recent studies in populations exhibiting polymorphisms in genes encoding enzymes which are involved in the metabolism of alcohol. Genetic polymorphisms lead to variations in the level of activity of these enzymes between individuals (*Genetic susceptibility*, p71) such that varying quantities of acetaldehyde are found from the same intake of ethanol. Studies in Japan, where such polymorphisms are frequent, have shown an increased risk of cancer in subjects with a genetic profile that is associated with higher acetaldehyde levels following alcohol drinking [6]. Results from Western populations, however, are less clear-cut.

Apart from being associated with an increased risk of several types of cancer, overconsumption of alcohol causes alcoholism (alcohol addiction), alcohol psychosis, chronic pancreatitis, liver cirrhosis, hypertension, haemorrhagic stroke and low birth weight in babies born to alcoholic mothers. Furthermore, inebriation associated with alcohol drinking is responsible for a high proportion of all accidents and injuries (15-40%, according

to the type of injury) and, in particular, traffic accidents. In global terms, immoderate consumption of alcohol is responsible for 1.5% of all deaths and 3.5% of disability-adjusted years of life lost (Table 2.5) [7]. In contrast, the regular consumption of a single alcoholic beverage per day has been clearly associated with a decreased risk of ischaemic heart disease [8]. This effect is likely to be due to an alcohol-induced increase in high-density



Fig. 2.15 An advertisement in the Tamil language targeted at Indian labourers in Malaysia.

lipoprotein-associated cholesterol, which exerts a protective effect against atherosclerosis. Protection is not evident for high levels of alcohol since the beneficial effect on cholesterol levels is probably offset by the alcohol-related increase in blood pressure, which increases the risk of ischaemic heart disease. Among British men in middle or old age, the consumption of an average of one or two units of

alcohol per day is associated with significantly lower levels of risk of all causes of mortality, compared with consumption of no alcohol or with consumption of substantial amounts [8]. Cholelithiasis (gallstones) is another disease prevented by moderate alcohol consumption.

The global effect of alcohol on health in a given population depends therefore on the level of consumption. The health impact

may be considered with reference to the increased risk of cancer, other diseases, and injuries, and also any decreased risk of ischaemic heart disease. Avoidance of excessive consumption of alcoholic beverages would prevent a range of cancers.

## REFERENCES

1. World Health Organization (1999) *Global Status Report on Alcohol*, Geneva, WHO.
2. IARC (1988) *Alcohol Drinking (IARC Monographs on the Evaluation of Carcinogenic Risks to Humans, Vol. 44)*, Lyon, IARC Press.
3. Potter JD, ed. (1997) *Food, Nutrition and the Prevention of Cancer: a Global Perspective*, Washington, DC, American Institute for Cancer Research.
4. Bandera EV, Freudenheim JL, Vena JE (2001) Alcohol consumption and lung cancer: a review of the epidemiologic evidence. *Cancer Epidemiol Biomarkers Prev*, 10: 813-821.
5. Tuyns AJ, Esteve J, Raymond L, Berrino F, Benhamou E, Blanchet F, Boffetta P, Crosignani P, del Moral A, Lehmann W (1988) Cancer of the larynx/hypopharynx, tobacco and alcohol: IARC international case-control study in Turin and Varese (Italy), Zaragoza and Navarra (Spain), Geneva (Switzerland) and Calvados (France). *Int J Cancer*, 41: 483-491.
6. Matsuo K, Hamajima N, Shinoda M, Hatooka S, Inoue M, Takezaki T, Tajima K (2001) Gene-environment interaction between an aldehyde dehydrogenase-2 (ALDH2) polymorphism and alcohol consumption for the risk of esophageal cancer. *Carcinogenesis*, 22: 913-916.
7. Murray CJL, Lopez AD (1996) Quantifying the burden of disease and injury attributable to ten major risk factors. In: Murray CJL, Lopez AD eds, *The Global Burden of Disease*, Geneva, World Health Organization, 295-324.
8. Doll R, Peto R, Hall E, Wheatley K, Gray R (1994) Mortality in relation to consumption of alcohol: 13 years' observations on male British doctors. *BMJ*, 309: 911-918.



# OCCUPATIONAL EXPOSURES

## SUMMARY

- > Many occupations and some specific chemicals encountered at work are associated with increased risk of cancer.
- > Occupational cancer most often involves the lung; other sites affected include the skin, urinary tract, nasal cavity and pleura.
- > Most occupational carcinogens have been eliminated from the workplace. However, in newly-industrialized countries, relevant exposures still pose a significant health risk.
- > Some past exposures still carry a significant cancer burden; in most European countries, use of asbestos was banned in the 1990s, but the peak mesothelioma incidence will occur around 2020.

The first reports of associations between risk of cancer and employment in particular occupations appeared during the 18th century (scrotal cancer among chimney sweeps [1]) and 19th century (bladder cancer in workers exposed to dyes [2]). However, the majority of studies establishing a link between an increased risk of cancer and a particular working environment were published between 1950 and 1975 [3]. Relatively few occupational carcinogens have been identified in the last 25 years.

### Identifying hazardous materials

The *IARC Monographs on the Evaluation of Carcinogenic Risks to Humans* evaluate data relevant to the carcinogenic hazard to humans as a consequence of exposure to particular chemical, physical and biological agents and mixtures [4]. Accordingly, evidence of carcinogenicity for most known or suspected occupational carcinogens has been evaluated in the *IARC Monographs* programme. At present, 25 chemicals, groups of chemi-

cals or mixtures for which exposures are mostly occupational, have been established as human carcinogens (Table 2.7). While some of these agents, such as asbestos, crystalline silica and heavy metals, are currently encountered in the workplaces of many countries, other agents have been phased out and are mainly of historical interest (e.g. mustard gas and 2-naphthylamine).

An additional 25 agents presenting a hazard on the basis of workplace exposure are classified as probably carcinogenic to humans. Most of these agents have been shown to be carcinogenic in experimental animals, and less than conclusive evidence of carcinogenicity in humans from epidemiological studies is available. They include chemicals and consequent exposures that are commonly in many countries, such as those associated with the use of formaldehyde and 1,3-butadiene (Table 2.8). In many instances, it is possible to associate



Fig. 2.16 The first cases of occupational cancer identified were scrotal cancers in chimney sweeps, in the late 18th century.

increased risk of cancer with a group of agents or a particular work environment rather than with a single compound. The hazard posed by polycyclic aromatic hydrocarbons is of particular interest. Although several individual polycyclic aromatic hydrocarbons are experimental carcinogens (three of them are listed in Table 2.8), human exposure always involves complex mixtures of these chemicals, often in variable proportions (e.g. soots, coal tars). Therefore, the determination of a hazard to humans must involve consideration of such mixtures and not the individual compounds. A large number of agents primarily encountered in an occupational context are classified as possibly carcinogenic to



Fig. 2.17 Asbestos insulation is common in buildings and presents a hazard when disturbed during demolition. (A) Protective clothing must be worn to avoid contact with (B) asbestos fibres .

Agent	Cancer site/cancer	Main industry/use
4-Aminobiphenyl	Bladder	Rubber manufacture
Arsenic and arsenic compounds*	Lung, skin	Glass, metals, pesticides
Asbestos	Lung, pleura, peritoneum	Insulation, filter material, textiles
Benzene	Leukaemia	Solvent, fuel
Benzidine	Bladder	Dye/pigment manufacture
Beryllium and beryllium compounds	Lung	Aerospace industry/metals
Bis(chloromethyl) ether	Lung	Chemical intermediate/by-product
Cadmium and cadmium compounds	Lung	Dye/pigment manufacture
Chloromethyl methyl ether	Lung	Chemical intermediate/by-product
Chromium[VI] compounds	Nasal cavity, lung	Metal plating, dye/pigment manufacture
Coal-tar pitches	Skin, lung, bladder	Building material, electrodes
Coal-tars	Skin, lung	Fuel
Ethylene oxide	Leukaemia	Chemical intermediate, sterilising agent
Mineral oils, untreated and mildly-treated	Skin	Lubricants
Mustard gas (sulfur mustard)	Pharynx, lung	War gas
2-Naphthylamine	Bladder	Dye/pigment manufacture
Nickel compounds	Nasal cavity, lung	Metallurgy, alloys, catalyst
Shale-oils	Skin	Lubricants, fuels
Silica, crystalline	Lung	Stone cutting, mining, foundries
Soots	Skin, lung	Pigments
Strong-inorganic-acid mists containing sulfuric acid	Larynx, lung	Metal, batteries
Talc containing asbestiform fibres	Lung	Paper, paints
2,3,7,8-Tetrachlorodibenzo- <i>para</i> -dioxin (TCDD)	Several organs	Contaminant
Vinyl chloride	Liver	Plastics monomer
Wood dust	Nasal cavity	Wood industry

\* This evaluation applies to the group of chemicals as a whole and not necessarily to all individual chemicals within the group.

Table 2.7 Chemicals classified as human carcinogens (IARC Group 1) for which exposures are mostly occupational.

humans, e.g. acetaldehyde, dichloromethane, inorganic lead compounds. For the majority of these chemicals, evidence of carcinogenicity comes from studies in experimental animals, and evi-

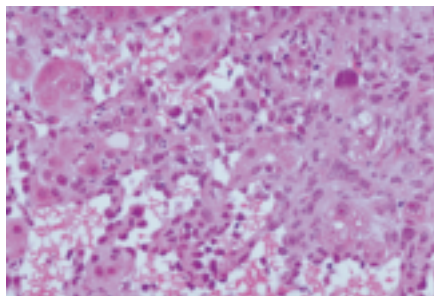

Fig. 2.18 Angiosarcoma of the liver caused by occupational exposure to vinyl chloride. The tumour is characterized by proliferation of vessel-like structures, lined by malignant, highly atypical endothelial cells.

dence of a carcinogenic outcome in humans is often lacking because human exposure occurs at the same time as exposure to many other agents, or for some other reason.

A number of industries and occupations have been subject to evaluation within the *Monographs* programme (Table 2.9). In some instances (e.g. wood dust in the wood industry), the agent(s) responsible for an increased risk of cancer is (are) well established, while in other cases (e.g. employment as a painter or in the rubber industry), an increased risk of cancer has been established, but no precise carcinogen has been identified. Furthermore, there are several agents known or suspected to cause cancer in humans to which humans are incidentally exposed in an occupational context (Table 2.10). Occupational exposure to

pharmaceutical drugs known or suspected to be carcinogenic can occur in pharmacies and during the administration of these drugs to patients by nursing staff (*Medicinal drugs*, p48). Hospital workers can be exposed to hepatitis B virus, food processors exposed to aflatoxins from contaminated foodstuff, outdoor workers exposed to ultraviolet radiation or diesel engine exhaust fumes and bar staff or waiters exposed to environmental tobacco smoke.

Current understanding of the relationship between occupational exposures and cancer is far from complete. For many chemicals known to cause cancer in experimental animals, no definitive evidence is available concerning route or extent of workplace exposure. Constructing and interpreting lists of

Agent	Cancer site/cancer	Main industry/use
Acrylonitrile	Lung, prostate, lymphoma	Plastics, rubber, textiles, monomer
Benz[a]anthracene	Lung, skin	Combustion fumes
Benzidine-based dyes	Bladder	Paper, leather, textile dyes
Benzo[a]pyrene	Lung, skin	Combustion fumes
1,3-Butadiene	Leukaemia, lymphoma	Plastics, rubber, monomer
Captafol	-	Pesticide
Chlorinated toluenes (trichlorobenzene, benzal chloride, benzyl chloride, benzoyl chloride)	Lung	Chemical intermediates
<i>para</i> -Chloro- <i>ortho</i> -toluidine (and its strong acid salts)	Bladder	Dye/pigment manufacture, textiles
4-Chloro- <i>ortho</i> -toluidine	Bladder	Dye/pigment manufacture, insecticide
Creosotes	Skin	Wood preservation
Dibenz[a,h]anthracene	Lung, skin	Combustion fumes
Diethyl sulfate	-	Chemical intermediate
Dimethylcarbamoyl chloride	-	Chemical intermediate
Dimethyl sulfate	-	Chemical intermediate
Epichlorohydrin	-	Plastics/resins monomer
Ethylene dibromide	-	Chemical intermediate, fumigant, fuels
Formaldehyde	Nasopharynx	Plastics, textiles, laboratory agent
Glycidol	-	Chemical intermediate, sterilising agent
4,4'-Methylenebis(2-chloroaniline) (MOCA)	Bladder	Rubber manufacture
Methyl methanesulfonate	-	Laboratory research
<i>ortho</i> -Toluidine	Bladder	Dye/pigment manufacture
Polychlorinated biphenyls	Liver, bile ducts, leukaemia, lymphoma	Electrical components
Styrene oxide	-	Plastics, chemical intermediate
Tetrachloroethylene	Oesophagus, lymphoma	Solvent, dry cleaning
Trichloroethylene	Liver, lymphoma	Solvent, dry cleaning, metal
Tris(2,3-dibromopropyl) phosphate	-	Plastics, textiles, flame retardant
Vinyl bromide	-	Plastics, textiles, monomer

Table 2.8 Chemicals classified as probably carcinogenic to humans (IARC Group 2A) for which exposures are mostly occupational.

chemical or physical carcinogenic agents and associating these agents with specific occupations and industries is complicated by a number of factors:

- Information on industrial processes and consequent exposures is frequently poor, and does not allow a complete evaluation of the impact of specific exposures in different occupations or industries;
- Exposure to chemicals known to present a carcinogenic hazard, such as vinyl chloride monomer and benzene, may occur at markedly different levels in different occupational situations;
- Changes in work practice occur over time, either because identified carcinogenic agents are replaced by other agents or (more frequently) because

new industrial processes or materials are introduced;

- Any list of occupations involving presumed exposure to an agent is likely to include only some of the situations in which a particular carcinogen may occur;
- Finally, the presence of a carcinogenic chemical in an occupational situation does not necessarily mean that workers are exposed to it. Conversely, the absence of identified carcinogens from a particular workplace does not exclude the possibility of a hazard and/or an as yet unidentified cause of cancer.

#### Particular chemicals and exposures

It is not possible to review here the carcinogenicity data for all recognized

occupational carcinogens. Limited information on certain of these hazards is summarized below [4,5].

#### *Aromatic amines*

Many members of this class of compounds are established or implicated as causing occupational cancer. By the mid-1950s, studies of workers in the chemical industry revealed that benzidine and 2-naphthylamine caused bladder cancer. It was also recognized about this time that rubber workers were subject to this malignancy, attributable to aromatic amines and 4-aminobiphenyl in particular. Later studies on occupational exposure to aromatic amines have not definitively established single compounds as carcinogenic, in many cases because

Industry, occupation	Cancer site/cancer (suspected cancer sites in parentheses)
<b>IARC Group 1</b> Aluminium production Auramine, manufacture of Boot and shoe manufacture and repair Coal gasification Coke production Furniture and cabinet making Haematite mining (underground) with exposure to radon Iron and steel founding Isopropanol manufacture (strong-acid process) Magenta, manufacture of Painter (mainly in the construction industry) Rubber industry (certain occupations)	Lung, bladder Bladder Nasal cavity, leukaemia Skin, lung, bladder Skin, lung, kidney Nasal cavity Lung  Lung Nasal cavity Bladder Lung Bladder, leukaemia
<b>IARC Group 2A</b> Art glass, glass containers and pressed ware (manufacture of) Hairdresser or barber (occupational exposure as a) Non-arsenical insecticides (occupational exposures in spraying and application of) Petroleum refining (occupational exposures in)	(Lung, stomach)  (Bladder, lung) (Lung, myeloma)  (Leukaemia, skin)
<b>IARC Group 2B</b> Carpentry and joinery Dry cleaning (occupational exposures in) Textile manufacturing industry (work in)	(Nasal cavity) (Bladder, oesophagus) (Nasal cavity, bladder)

**Table 2.9** Industries and occupations classified as carcinogenic to humans (IARC Group 1), probably carcinogenic to humans (IARC Group 2A) or possibly carcinogenic to humans (IARC Group 2B).

workers were exposed to more than one such agent. Nonetheless, benzidine-based dyes and 4,4'-methylenebis (2-chloroaniline) (known as MOCA, a curing agent for plastics) are implicated. The manufacture of auramine has been shown to cause bladder cancer, but the causative agent is not known.

#### *Benzene*

Occupational exposure to benzene may occur in the chemical and petroleum industries; it is used as a solvent and intermediate. The compound is known to cause leukaemia, most relevant studies implicating non-lymphocytic leukaemia, and myelogenous leukaemia in particular [6].

#### *Asbestos and other fibres*

Cancer caused by inhalation of asbestos dust has been recognized since the 1950s. All forms of asbestos, including chrysotile and the amphibole, crocidolite, cause lung cancer and mesothelioma, an otherwise rare tumour derived from the lining of the peritoneum, pericardium or pleura. Apart from asbestos miners, those exposed include construction, demolition, shipbuilding, insulation and brake workers. Fibre size is a crucial factor determining the carcinogenicity of asbestos. Evidence suggests that insulation glass wool, rock wool and slag wool, which are used as replacements for asbestos in some applications, do not

cause increased risk of lung cancer or mesothelioma, although ceramic fibres and certain special-purpose glass wools are possible carcinogens [7].

#### *Metals*

Cancer of the lung can be caused by exposure to inorganic arsenic in mining and copper smelting. An increased incidence of lung cancer has also been recorded among workers in chromate-producing industries and among chromium platers and chromium alloy workers. Increased risk is predominantly associated with hexavalent chromium compounds. Nickel refining carries a carcinogenic risk in processes involving nickel (sub)sulfides, oxides and soluble nickel salts.

#### *Coal tar, coal gas production and iron founding*

Coal tar pitches and coal tar vapour are encountered in a variety of occupations including coke production, coal gasification and roofing. These mixtures produce cancers of the skin and at other sites including the urinary and respiratory systems. Work in iron and steel founding is also associated with an elevated risk of lung cancer; in addition to coal-related emissions, such work may involve exposure to silica, metal fumes and formaldehyde.

#### *Wood work*

Nasal adenocarcinomas are caused by exposures in the furniture- and cabinet-making industry, mainly among people exposed to wood dust.

#### *Painting*

Approximately 200,000 workers worldwide are employed in paint manufacture, and several million are believed to work as painters, including in specialist painting such as in vehicle production and repair. Painters are exposed to hydrocarbon and chlorinated solvents, dyes, polyesters, phenol-formaldehyde and polyurethane resins. A 40% excess risk of lung cancer has been consistently recorded, and cannot be explained by smoking alone.



Agent	Cancer site/cancer
<b>IARC Group 1</b>	
Aflatoxins	Liver
Chronic infection with hepatitis B virus	Liver
Chronic infection with hepatitis C virus	Liver
Erionite	Lung, pleura
Radon and its decay products	Lung
Solar radiation	Skin
Environmental tobacco smoke	Lung
<b>IARC Group 2A</b>	
Diesel engine exhaust	Lung, bladder
Ultraviolet radiation A	Skin
Ultraviolet radiation B	Skin
Ultraviolet radiation C	Skin

**Table 2.10** Agents and mixtures which occur mainly in the general environment but to which exposure may also occur in an occupational context.

### A worldwide problem

Evidence on occupational cancer has been obtained mainly in developed countries. To a large extent, the critical data concern the effects of high exposure levels as a consequence of industrial practice during the first half of the 20th century. Few studies have been conducted in developing countries, other than some in China. Since the period, twenty to thirty years ago, to which most studies pertain, there have been major changes in the geographical distribution of industrial production. These have involved extensive transfer of technology, sometimes obsolete, from highly-industrialized countries to developing countries in South America and in Asia. For example, the manufacture of asbestos-based products is relocating to countries such as Brazil, India, Pakistan and the Republic of Korea, where health and safety standards and requirements may not be so stringent (*Reduction of occupational and environmental exposures*, p135). Occupational exposures to carcinogenic environments are increasing in developing countries as a result of transfers of hazardous industries and the establishment of new local

industries as part of a rapid global process of industrialization [8].

A particular problem in developing countries is that much industrial activity takes place in multiple small-scale operations. These small industries are often characterized by old machinery, unsafe buildings, employees with minimal training and education and employers with limited financial resources. Protective clothing, respirators, gloves and other safety equipment are seldom available or used. The small operations tend to be geographically scattered and inaccessible to inspections by health and safety enforcement agencies. Although precise data are lacking, the greatest impact of occupational carcinogens in developing countries is likely to be in the less organized sectors of the relevant industries. Examples include the use of asbestos in building construction, exposure to crystalline silica in mining and mining construction, and the occurrence of polycyclic aromatic hydrocarbons and heavy metals in small-scale metal workshops and in mechanical repair shops.

The most generally accepted estimates of the proportion of cancers attributable



**Fig. 2.19** Asphalt road-workers (shown here in India) are exposed to polycyclic aromatic hydrocarbons.



**Fig. 2.20** In modern mines (such as those of Charbonnages de France), the prevention of occupational risk is a major concern, which is being addressed on both collective (reduction of dust, organization of transport) and individual (use of suitable protection equipment) levels.



**Fig. 2.21** Textile dyeing in Ahmedabad, India. Protection against occupational exposures is often suboptimal in developing countries.

to occupational exposures in developed countries are in the range of 4-5% [9,10]. Lung cancer is probably the most frequent of these cancers. However, the

estimates do not apply uniformly to both sexes or to the different social classes. Among those actually exposed to occupational carcinogens (those doing manu-

al work in mining, agriculture and industry, for example), the proportion of cancer attributable to such exposure is estimated to be about 20%.

## REFERENCES

1. Pott P, ed. (1775) *Chirurgical Observations*, London, Hawes, Clarke and Collins.
2. Rhen L (1895) Blasengeschwülste bei Fuchsin-Arbeitern. *Arch Klin Chir*, 50: 588-600.
3. Monson R (1996) Occupation. In: Schottenfeld D, Fraumeni, JF eds, *Cancer Epidemiology and Prevention*, New York, Oxford University Press, 373-405.
4. IARC (1972-2001) *IARC Monographs on the Evaluation of Carcinogenic Risks to Humans, Vols 1-78*, Lyon, IARCPress.
5. Alderson M (1986) *Occupational Cancer*, Butterworths.
6. Hayes RB, Songnian Y, Dosemeci M, Linet M (2001) Benzene and lymphohematopoietic malignancies in humans. *Am J Ind Med*, 40: 117-126.

7. IARC (2002) *Man-made Vitreous Fibres, IARC Monographs on the Evaluation of Carcinogenic Risks to Humans Vol. 81*, Lyon, IARCPress.
8. Pearce N, Matos E, Vainio H, Boffetta P, Kogevinas M, eds (1994) *Occupational Cancer in Developing Countries (IARC Scientific Publications, No. 129)*, Lyon, IARCPress.
9. Harvard Center for Cancer Prevention (1996) Harvard report on cancer prevention. Causes of human cancer. Occupation. *Cancer Causes Control*, 7 Suppl 1: S19-S22.
10. Doll R, Peto R (1981) The causes of cancer: quantitative estimates of avoidable risks of cancer in the United States today. *J Natl Cancer Inst*, 66: 1191-1308.

## WEBSITES

- NCI Occupational Epidemiology Branch:  
<http://dceg.cancer.gov/ebp/oeb/>
- The American Conference of Governmental Industrial Hygienists:  
<http://www.acgih.org/home.htm>
- International Programme on Chemical Safety (IPCS):  
<http://www.who.int/pcs/index.htm>
- IARC Monographs programme:  
<http://monographs.iarc.fr>

# ENVIRONMENTAL POLLUTION

## SUMMARY

- > Pollution of air, water and soil is estimated to account for 1-4% of all cancers.
- > A small proportion of lung cancer (<5%) is attributable to outdoor air pollution by industrial effluent, engine exhaust products and other toxins.
- > Carcinogenic indoor air pollutants include tobacco smoke, and cooking fumes in particular regions, including parts of Asia.
- > Chlorofluorocarbons cause destruction of the ozone layer and enhance the risk of skin cancer through increased ultraviolet radiation.
- > Contamination of drinking water is not a general carcinogenic hazard, but high levels of arsenic and chlorination by-products in some communities carry a risk.

In a broad sense, “environmental factors” are implicated in the causation of the majority of human cancers [1]. In respect of many such environmental factors, such as active smoking, alcohol intake, sun exposure and dietary make-up, individuals exercise a degree of control over their level of exposure. However in the present context, “environmental pollution” refers to a specific subset of cancer-causing environmental factors; namely, contaminants of air, water and soil. One characteristic of environmental pollutants is that individuals lack control over their level of exposure. The carcinogenic pollutants for which most information is available include asbestos (referring here to non-occupational exposure), toxic agents in urban air, indoor air pollutants and chlorination by-products and other contaminants of drinking water. Relevant risk fac-

tors include place of residence: whether rural or urban, and the relationship to major industrial emission sources. Various determinations suggest that environmental pollution accounts for 1-4% of the total burden of cancer in developed countries [2,3].

### Asbestos

Asbestos is one of the best characterized causes of human cancer in an occupational context (*Occupational exposures*, p33); the carcinogenic hazard associated with inhalation of asbestos dust has been recognized since the 1950s [1]. Non-occupational exposure to asbestos may occur domestically and as a consequence of localized pollution. Cohabitants of asbestos workers may be exposed to dust brought home on clothes. The installation, degradation, removal and repair of asbestos-containing products in the context of household maintenance represents another mode of domestic exposure. Further afield, whole neighbourhoods may be subject to outdoor pollution as a result of local asbestos mining or manufacture. The erosion of asbestos or asbestiform rocks may constitute a natural source of asbestos exposure in some parts of the world.

In common with occupational exposure, exposure to asbestos under domestic circumstances results in an increased risk of mesothelioma, a rare tumour derived from the cells lining the peritoneum, pericardium or pleura. Likewise, non-occupational exposure to asbestos may cause lung cancer, particularly among smokers [4]. A consequence of neighbourhood exposure, namely a very high incidence of mesothelioma, is evident among inhabitants of villages in Turkey where houses are built from erionite (a zeolite mineral).

### Outdoor air pollution

Ambient air pollution has been implicated as a cause of various health problems, including cancer, and in particular as a cause of lung cancer. Air may be polluted

by a complex mixture of different gaseous and particulate components. The concentrations of specific components vary greatly with locality and time. A critical exposure scenario is therefore hard to define, particularly as relevant biological mechanisms are largely unknown. It is, however, possible to attribute at least some carcinogenic risk to particular atmospheric pollutants, including benzo[a]pyrene, benzene, some metals, particulate matter (especially fine particles) in general, and possibly ozone. Over recent decades, emission levels have been tending to decrease in developed countries, so that concentrations of traditional industrial air pollutants such as sulfur dioxide and particulate matter have fallen. However, vehicular exhaust remains a continuing or even increasing



Fig. 2.22 Fuel used for heating and cooking, and high levels of cooking oil vapours are responsible for the high incidence of lung cancer among women in some parts of Asia.



Fig. 2.23 Air pollution is common to many large cities throughout the world.

Air pollutant	WHO Air Quality Guideline, annual average	Number of cities with data	Population in those cities (millions)	% of population in those cities exposed above the AQG
Sulfur dioxide (SO <sub>2</sub> )	50 µg/m <sup>3</sup>	100	61	14%
Black smoke	50 µg/m <sup>3</sup>	81	52	19%
Total suspended particles	60 µg/m <sup>3</sup>	75	25	52%

Table 2.11 The proportion of the population in Western European cities exposed to air pollutants at levels above the WHO Air Quality Guidelines (AQG), 1995.

problem. Engine combustion products include volatile organic compounds (benzene, toluene, xylenes and acetylene), oxides of nitrogen (NO<sub>x</sub>) and fine particulates (carbon, adsorbed organic material and traces of metallic compounds). In developing countries, outdoor air pollution is likely to represent a greater public health problem than in more developed countries, because of poorly regulated use of coal, wood and biomass (e.g. animal dung, crop residues) for electricity production and heating, in addition to vehicle emissions in urban areas. Although the proportion of global energy derived from biomass fuels decreased from 50% in 1900 to about 13% in 2000, use of such fuels is now increasing in some impoverished regions [5]. Human exposure to air pollution is nevertheless hard to estimate. In a study based on air monitoring and population data for

100 Western European urban areas, the proportion of the population exposed ranged from 14% to 52%, depending on the indicator pollutant used (Table 2.11) [6]. Numerous studies have compared residence in urban areas, where air is considered to be more polluted, to residence in rural areas as a risk factor for lung cancer [7]. In general, lung cancer rates were higher in urban areas and, in some studies, were correlated with levels of specific pollutants such as benzo[a]pyrene, metals and particulate matter, or with mutagenicity of particulate extracts in bacterial assay systems. Other studies have attempted to address exposure to specific components of outdoor air, providing risk estimates in relation to quantitative or semi-quantitative exposure to pollutants. In general, these studies have provided evidence for an increased risk of lung

cancer among residents in areas with higher levels of air pollution. Table 2.12 summarizes the results of three of the best designed studies (in particular these studies controlled for the possible concomitant effect of smoking): no matter which pollutant is considered, the results suggest a moderate increase in the risk of lung cancer. Localized air pollution may be a hazard in relation to residence near to specific sources of pollution, such as petroleum refineries, metal manufacturing plants, iron foundries, incinerator plants and smelters. In general, an increased risk of lung cancer in the proximity of pollution sources has been demonstrated. In three Scottish towns, for example, increased lung cancer mortality occurred in the vicinity of foundries from the mid-1960s to the mid-1970s and later subsided in parallel with emission reductions [8]. Similar

Study	Population, follow-up	Number of subjects	Exposure range	Contrast / Controls	Relative risk of lung cancer (95% CI)
Dockery et al. 1993	6 Cities, USA, 1974-91	8,111	FP 11-30 µg/m <sup>3</sup>	Highest vs. lowest city	FP: 1.37 (1.11 - 1.68)
Pope et al. 1995	151 Areas, USA, 1982-89	552,138	FP 9-33 µg/m <sup>3</sup> Sulfur dioxide: 3.6-23 µg/m <sup>3</sup>	Highest vs. lowest areas	FP: 1.03 (0.80 - 1.33) Sulfur dioxide: 1.36 (1.11 - 1.66)
Beeson et al. 1998	California, male non-smokers, 1977-82	2,278	FP 10-80 µg/m <sup>3</sup> Sulfur dioxide: 0.6-11 ppb Ozone 4-40 ppb	Increment based on interquartile range (FP 24 µg/m <sup>3</sup> ; Sulfur dioxide 3.7 ppb; Ozone 2.1 ppb)	FP: 5.21 (1.94 -13.99) Sulfur dioxide: 2.66 (1.62 - 4.39) Ozone: 2.23 (0.79 - 6.34)

Table 2.12 Studies indicating an increased risk of lung cancer associated with exposure to atmospheric pollutants. FP = fine particles.





Fig. 2.24 Automobile emissions are a major source of atmospheric pollution.

results were obtained in studies focusing on industrial emission of arsenic from coal burning and non-ferrous metal smelting. The evidence for an increased risk of cancers other than lung cancer from outdoor air pollution is inconclusive at present.

Air pollution by chlorofluorocarbons (CFCs) is believed to be indirectly responsible for increases in skin cancers around the globe. These chemicals, including halons, carbon tetrachloride, and methyl chloroform, are emitted from home air conditioners, foam cushions, and many other products. Chlorofluorocarbons are carried by winds into the stratosphere, where the action of strong solar radiation releases chlorine and bromine atoms that react with, and thereby eliminate, molecules of ozone. Depletion of the ozone layer is believed to be responsible for global increases in UVB radiation (*Radiation*, p51) [9].

### Indoor air pollution

Very high lung cancer rates occur in some regions of China and other Asian countries among non-smoking women who spend much of their time at home. Indoor air pollution occurs as a result of combustion sources used for heating and cooking, and may also be a consequence of cooking oil vapours. Three determinants of indoor air pollution (“smokiness”) have been studied: (i) heating fuel (type of fuel, type of stove or central heating, ventilation, living area, subjective smokiness), (ii) cooking fuel (type of fuel, type of stove or open pit, ventilation of kitchen, location of cooking area in residence, frequency of cooking, smokiness) and (iii) fumes from frying oils (type of oil, frequency of frying, eye irrita-

tion when cooking). The evidence of carcinogenic hazard is particularly strong for cooking oil vapours from Chinese-style cooking and is supported by experimental data [10]. In circumstances of high exposure, more than 50% of cases of lung cancer among women can be attributed to indoor air pollution.

Tobacco smoke is an important source of indoor air pollution (*Tobacco*, p22). In adult non-smokers, chronic exposure to environmental tobacco smoke increases mortality from lung cancer by between 20% and 30% [11]. Among adults, exposure to environmental tobacco smoke has been linked to lung cancer and heart disease, whilst environmental exposure to tobacco smoke in children has been identified as a cause of respiratory disease, middle ear disease, asthma attacks and sudden infant death syndrome.

### Water and soil pollution

Access to unpolluted water is one of the basic requirements of human health. The greatest concern relates to infectious disease. Water quality is influenced by seasons, geology of the soil, and discharges of agriculture and industry. Microbiological contamination of water is controlled by disinfection methods based on oxidants like chlorine, hypochlorite, chloramine, and ozone. In consequence, drinking water may contain a variety of potentially carcinogenic agents, including chlorination by-products and arsenic. It is desirable to reduce such contamination without reducing the rigour of disinfection procedures. Chlorination by-products result from the interaction of chlorine with organic chemicals, the level of which determines the concentration of by-products. Among the many halogenated compounds that may be formed, trihalomethanes and chloroform are those most commonly found. Concentrations of trihalomethanes vary widely, mainly due to the occurrence of water contamination by organic chemicals [12]. Studies on bladder cancer have suggested an increased risk associated with consumption of chlorinated drinking water [13]. Doubts remain as to whether such associations are causal because of the way in which the studies measured expo-

sure [14]. Given the large number of people exposed to chlorination by-products, however, even a small increase in risk, if real, would result in a substantial number of cases attributable to this factor.

Arsenic causes cancer in the skin, lung and other organs [15]. The main source of environmental exposure to arsenic for the general population is through ingestion of contaminated water. High exposure to arsenic from drinking water is found in several areas of Alaska, Argentina, Bangladesh, Chile, India, Mexico, Mongolia, Taiwan and the USA. There is strong evidence of an increased risk of bladder, skin and lung cancers following consumption of water with high arsenic contamination [14]. The data on other cancers, such as those of the liver, colon and kidney, are less clear but suggestive of a systemic effect. The studies have been conducted in areas of high arsenic content (typically above 200 µg/L). The risk at lower arsenic concentrations (e.g. above 5 µg/L, a level to which 5% of the Finnish population is exposed, [16]) is not established, but an increased risk of blad-



Fig. 2.25 Industrial atmospheric emissions may include carcinogens.



Fig. 2.26 Adequate supplies of clean water are essential for public health, including cancer prevention.

der cancer of the order of 50% is plausible. Several other groups of pollutants of drinking water have been investigated as possible sources of cancer risk in humans [14,17]. They include organic compounds derived from industrial, commercial and agricultural activities and in particular from waste sites, as well as nitrites, nitrates, radionuclides and asbestos. For most pollutants, the results are inconclusive. However, an increased risk of stomach cancer has been repeatedly reported in areas with high nitrate levels in drinking water, and an increased risk of leukaemia

has been observed among residents in areas with elevated levels of radium in drinking water.

The atmosphere, and more particularly water and soil, may be polluted by a range of toxic organic compounds specifically including persistent pesticides, by-products of combustion, such as polychlorinated dibenzo-*p*-dioxins (2,3,7,8-tetrachlorodibenzodioxin, TCDD, being of greatest concern) and dibenzofurans, and industrial products, such as polychlorinated biphenyls (PCBs) and polybrominated biphenyls (PBBs). These compounds are

chemically stable, are often passed along the food chain and may accumulate in fatty tissue. In most cases, they were recognized as a carcinogenic hazard to humans on the basis of increased cancer risk in small but relatively heavily exposed groups who were occupationally exposed, in some cases as a result of industrial breakdowns or malfunctions (*Occupational exposures*, p33). Therefore the hazard posed to the general population can only be determined on the basis of extrapolation using mathematical models.

## REFERENCES

1. Tomatis L, Aitio A, Day NE, Heseltine E, Kaldor J, Miller AB, Parkin DM, Riboli E, eds (1990) *Cancer: Causes, Occurrence and Control (IARC Scientific Publications, No. 100)*, Lyon, IARC Press.
2. Doll R, Peto R (1981) The causes of cancer: quantitative estimates of avoidable risks of cancer in the United States today. *J Natl Cancer Inst*, 66: 1191-1308.
3. Harvard Center for Cancer Prevention (1996) Harvard report on cancer prevention. Causes of human cancer. Environmental pollution. *Cancer Causes Control*, 7 Suppl 1: S37-S38.
4. Health Effects Institute (1991) *Asbestos in Public and Commercial Buildings: A Literature Review and Synthesis of Current Knowledge*, Boston, MA, Health Effects Institute.
5. Bruce N, Perez-Padilla R, Albalak R (2000) Indoor air pollution in developing countries: a major environmental and public health challenge. *Bull World Health Organ*, 78: 1078-1092.
6. WHO European Centre for Environment and Health (1995) Air pollution. In: *Concern for Europe's Tomorrow: Health and the Environment in the WHO European Region*, Stuttgart, Wissenschaftliche Verlagsgesellschaft, 139-175.
7. Katsouyanni K, Pershagen G (1997) Ambient air pollution exposure and cancer. *Cancer Causes Control*, 8: 284-291.
8. Williams FL, Lloyd OL (1988) The epidemic of respiratory cancer in the town of Armadale: the use of long-term epidemiological surveillance to test a causal hypothesis. *Public Health*, 102: 531-538.
9. EPA (1999) *National Air Quality and Emissions Trends Report, 1999*. Office of Air Quality Planning & Standards. United States Environmental Protection Agency.

10. Zhong L, Goldberg MS, Parent ME, Hanley JA (1999) Risk of developing lung cancer in relation to exposure to fumes from Chinese-style cooking. *Scand J Work Environ Health*, 25: 309-316.
11. World Health Organization (2000) *Fact Sheet No. 187: Air Pollution*, WHO, Geneva.
12. IARC (1991) *Chlorinated Drinking-Water; Chlorination by-Products; Some Other Halogenated Compounds; Cobalt and Cobalt Compounds (IARC Monographs on the Evaluation of Carcinogenic Risks to Humans, Vol. 52)*, Lyon, IARC Press.
13. Morris RD, Audet AM, Angelillo IF, Chalmers TC, Mosteller F (1992) Chlorination, chlorination by-products, and cancer: a meta-analysis. *Am J Public Health*, 82: 955-963.
14. Cantor KP (1997) Drinking water and cancer. *Cancer Causes Control*, 8: 292-308.
15. IARC (1987) *Overall Evaluations of Carcinogenicity: An Updating of IARC Monographs Volumes 1 to 42 (IARC Monographs on the Evaluation of Carcinogenic Risks to Humans, Suppl. 7)*, Lyon, IARC Press.
16. Kurttio P, Pukkala E, Kahelin H, Auvinen A, Pekkanen J (1999) Arsenic concentrations in well water and risk of bladder and kidney cancer in Finland. *Environ Health Perspect*, 107: 705-710.
17. Cantor KP (1996) Arsenic in drinking water: how much is too much? *Epidemiology*, 7: 113-115.

## WEBSITES

United States Environmental Protection Agency:  
<http://www.epa.gov/>

The Health Effects Institute (a partnership of the US Environmental Protection Agency and industry):  
<http://www.healtheffects.org/index.html>

United Nations Environment Programme:  
<http://www.unep.org/>

# FOOD CONTAMINANTS

## SUMMARY

- > Food may be contaminated by natural or man-made toxins, including substances shown to be carcinogenic in experimental animals and, in some cases, in humans.
- > Naturally-occurring carcinogens include mycotoxins, particularly aflatoxins, which contribute to causation of liver cancer in Africa and Asia.
- > Food can be contaminated by residual pesticides. Small quantities of heterocyclic amines, which are mutagenic and carcinogenic in experimental animals, can be generated during food processing and cooking.
- > Means to reduce and, in some cases, eliminate food contamination include storage hygiene, appropriately enforced by regulation.
- > The burden of cancer attributable to food contamination is difficult to quantify, except in some defined instances (e.g. aflatoxin B<sub>1</sub>).

Differences between diets eaten by diverse communities, in terms of amount and relative proportion of the major food groupings (vegetable content, fat content etc) exert a major influence on the distribution of cancers of the digestive tract and some other organs (*Diet and nutrition*, p62). By comparison, only a very minor part of the worldwide burden of cancer is attributable to contamination of foodstuffs by toxins recognized to be chemical carcinogens. Despite this global perspective, the issue warrants close attention because it may be a serious concern for particular communities and, irrespective of demonstrated cancer causation, food contamination can be rectified. Removal of carcinogenic contaminants requires that such

contaminants are identified, and that ways are found to avoid their inclusion, or generation, in food. Such public health aims are amenable to regulation. Contamination of water is not included in the present discussion, but is considered elsewhere (*Environmental pollution*, p39).

Contamination of food may occur directly during its production, storage and preparation. For example, grains and cereals are subject to fungal growth and contamination by mycotoxins. Indirect contamination of food can occur when animals have been given contaminated feed or been otherwise treated with various products. The most contentious residues occurring in meat, milk and eggs are antibacterial drugs, hormonal growth promoters and certain pesticides, heavy metals and industrial chemicals. An additional category of contaminants comprises those generated in the course of food preparation.

### Naturally occurring contaminants

Food may be contaminated by mycotoxins, the presence of one such agent being indicative of the possibility that others are also present. A single fungus can produce several mycotoxins and food or feed can be contaminated by several varieties of mycotoxin-producing fungi. Only a small number of mycotoxins have been categorized as carcinogenic hazards.

#### Aflatoxins

Aflatoxins are a family of related compounds (designated B<sub>1</sub>, B<sub>2</sub>, G<sub>1</sub>, G<sub>2</sub> and M) which occur as food contaminants in hot, humid parts of the world, with particularly high levels in traditional diets based upon maize and groundnuts (peanuts) of sub-Saharan Africa, South-East Asia and South America. Aflatoxins are products of the *Aspergillus* fungi and particularly accumulate during storage of grains. In many countries, including Europe and North America, aflatoxin contamination is recognized as a hazard and aflatoxin levels in susceptible foods are subject to monitoring and associated regulatory control.

The detection of aflatoxin adducts on serum albumin is indicative of human exposure and, in regions where aflatoxins are a common food contaminant, such adducts are detectable in up to 95% of the population. In these regions, chronic hepatitis virus infection (essentially involving hepatitis B virus, HBV) occurs in up to 20% of the population. Together, aflatoxin exposure and HBV infection are the main risk factors accounting for the high incidence of hepatocellular carcinoma in some regions of Africa, Asia and South America [1].

Aflatoxin B<sub>1</sub> (the most common aflatoxin) causes liver cancer in experimental animals. In liver cells, aflatoxin B<sub>1</sub> is metabolized to form an epoxide which binds to the N7 position of specific guanines, leading to the formation of G to T transversions [2] (*Carcinogen activation and DNA repair*, p89). Mutations induced by aflatoxin B<sub>1</sub> are found in several genes involved in hepatocellular carcinogenesis. In particular, aflatoxin B<sub>1</sub> induces a typical



Fig. 2.27 Groundnuts (peanuts) are particularly susceptible to contamination with aflatoxins in some regions, such as West Africa.

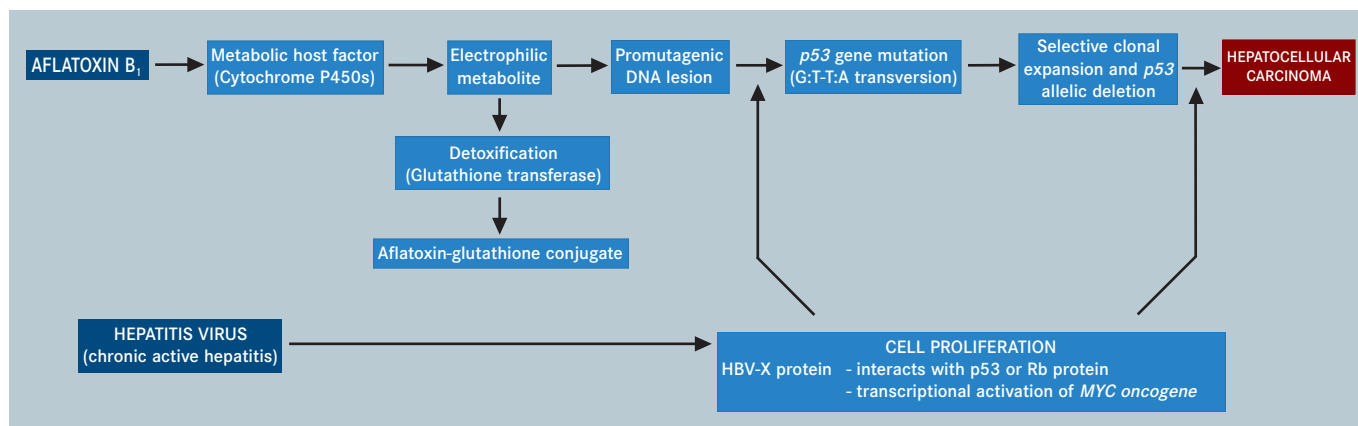

Fig. 2.28 Interaction between aflatoxin B<sub>1</sub> and HBV infection in the pathogenesis of human hepatocellular carcinoma.

mutation at codon 249 in the *p53* gene (AGG to AGT, arginine to serine) (Fig. 2.28). This mutation is rarely found in hepatocellular carcinomas in areas of low aflatoxin exposure, but occurs in up to 60% of hepatocellular carcinomas in regions of very high exposure to aflatoxins [3]. Naturally occurring aflatoxins are categorized by IARC as Group 1 carcinogens (causing cancer in humans).

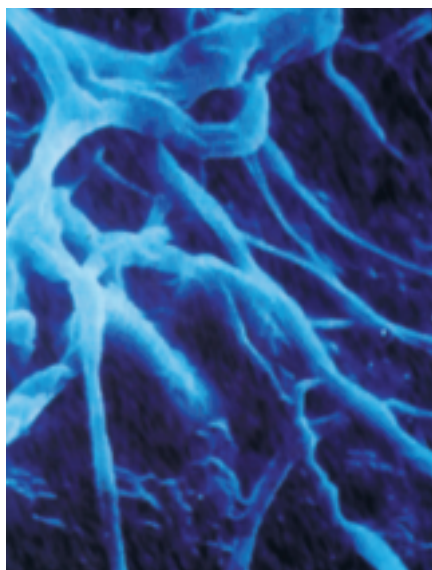

Fig. 2.29 The fungi *Aspergillus* and *Penicillium* produce ochratoxins in humid conditions on commodities used for the production of human or animal food.

#### *Fusarium*

*Fusarium verticillioides* (previously *F. moniliforme*), which is ubiquitous on maize, produces the toxins fumonisin B<sub>1</sub> and B<sub>2</sub> and fusarin C, under warm dry conditions. Incidence of oesophageal cancer incidence has been related to the occurrence of *F. verticillioides* or its toxins in maize. *Fusarium sporotrichioides* produces T-2 toxin, which may have played a significant role in large-scale human poisonings in Siberia in the last century and may be carcinogenic [4].

#### *Ochratoxin*

Ochratoxin A, also a fungal metabolite (Fig. 2.29), has been classed as a possible human carcinogen. This mycotoxin may contaminate grain and pork products and has been detected in human blood and milk. Several studies have suggested correlations between ochratoxin A and Balkan endemic nephropathy and between geographical distribution of Balkan endemic nephropathy and high incidence of urothelial urinary tract tumours. In mice, administration of ochratoxin A causes increased incidence of hepatocellular carcinomas and other tumour types [4,5].

#### *Pyrrolizidine alkaloids*

Pyrrolizidine alkaloids (including lasiocarpine and monocrotaline) are naturally occurring plant toxins which may be ingested by animals, and by humans eat-

ing some medicinal plants (e.g. comfrey) or honey, in some areas [6]. Several pyrrolizidine alkaloids have been found to cause DNA damage and show mutagenic properties *in vitro*. Chronic consumption of some pyrrolizidine alkaloids may cause liver tumours in rodents, but has not been associated with cancer in humans.

#### *Bracken*

Animals grazing on bracken (genus *Pteridium*) may show various signs of toxicity, including tumours in the upper gastrointestinal tract and bladder, which are attributable to the carcinogen ptaquiloside [7]. The corresponding glucoside may be present in bracken at a concentration of 13,000 ppm. Metabolism of this compound gives rise to alkylation adducts in DNA. Milk from cows fed on bracken fern causes cancer in experimental animals. Bracken may pose a carcinogenic hazard for humans in population identified as exposed in Japan, Costa Rica and the United Kingdom.

#### **Contamination by industrial chemicals**

Certain organochlorines, including DDT and other pesticides, are resistant to degradation, are very lipid-soluble and hence persist in the environment and are bioconcentrated up the human food chain. Related industrial chemicals such as polychlorinated biphenyls are subject to the same effect. DDT and a number of



## MOLECULAR EPIDEMIOLOGY

In 1982, “molecular cancer epidemiology” was defined as “an approach in which advanced laboratory methods are used in combination with analytic epidemiology to identify at the biochemical or molecular level specific exogenous and/or host factors that play a role in human cancer causation” (Perera FP, Weinstein IB, *J Chron Dis* 35: 581-600, 1982). Four categories of biomarkers were described: internal dose, biologically effective dose, response, and susceptibility. The hope was that, by introducing biomarkers into epidemiology, researchers “should be able to predict human risks more precisely than hitherto possible”. Since then, molecular cancer epidemiology has evolved rapidly, with special programmes in many schools of public health.

The stated goal of molecular cancer epidemiology is the prevention of cancer. Considerable molecular epidemiologic research has focused on environmental causes because many lines of evidence indicate that the factors that determine the great majority of cancers incidence are largely exogenous and hence preventable (Lichtenstein P et al., *N Engl J Med* 343: 78-85, 2000). These include exposures related to lifestyle and occupation, and pollutants in air, water, and the food supply. This awareness has lent greater urgency to the search for more powerful tools in the form of early-warning systems to identify causal environmental agents and flag risks well before the malignant process is entrenched.

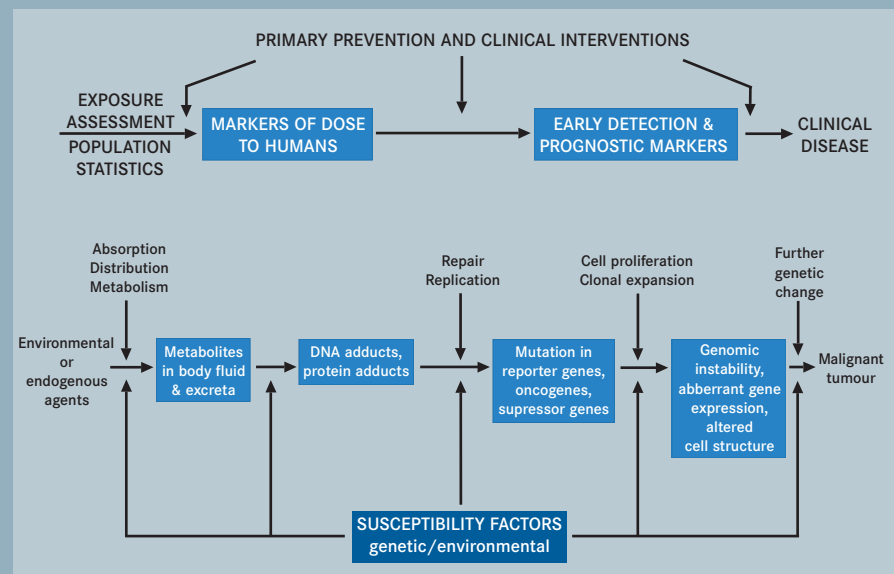

Potential molecular endpoints (specified in the lower section) that may serve as the basis for molecular epidemiological studies. These endpoints may be indicative of biological processes contributing to cancer development as shown in the upper section.

The potential contribution of molecular epidemiology includes: providing evidence that environmental agents pose carcinogenic risks, helping establish the causal roles of environmental factors in cancer, identifying environment-susceptibility interactions and populations at greatest risk and developing new intervention strategies. A recent review of the field (Perera F, *J Natl Cancer Inst*, 92: 602-612, 2000) critically evaluated the progress to date using as illustration research on tobacco smoke, polycyclic aromatic hydrocarbons, aflatoxin B<sub>1</sub>, benzene and hepatitis B virus and their role in lung, breast, liver cancer and leukaemia. It concluded

that molecular epidemiology has identified a number of carcinogenic hazards, in some cases providing definitive etiologic data, furthering our understanding of individual genetic and acquired susceptibility to environmental carcinogens. However, molecular epidemiology has not yet led to broad policy changes to prevent or to reduce exposure to carcinogens. What is now needed is timely translation of existing data into risk assessment and public health policy as well as focused research to fill gaps in scientific knowledge.

other organochlorine pesticides cause liver cancer in rats. DDT in particular has been associated with increased risk of pancreatic cancer, breast cancer, lymphoma and leukaemia in humans. Some organochlorines exhibit sex steroid activity in relevant assay systems, and these pesticides are consid-

ered to have the potential to disrupt endocrine-regulated homeostasis. Attempts have been made to correlate levels of organochlorines and polychlorinated biphenyls in breast tissue with breast cancer risk in several communities, but without clear-cut results [8]. For the major pesticides, international

regulations exist with regard to permissible amounts of residues in foods – the ADI, or acceptable daily intake, being the primary reference level for such exposures. ADI levels are determined by expert groups convened by WHO, and published as the *WHO Pesticide Residue Series*.



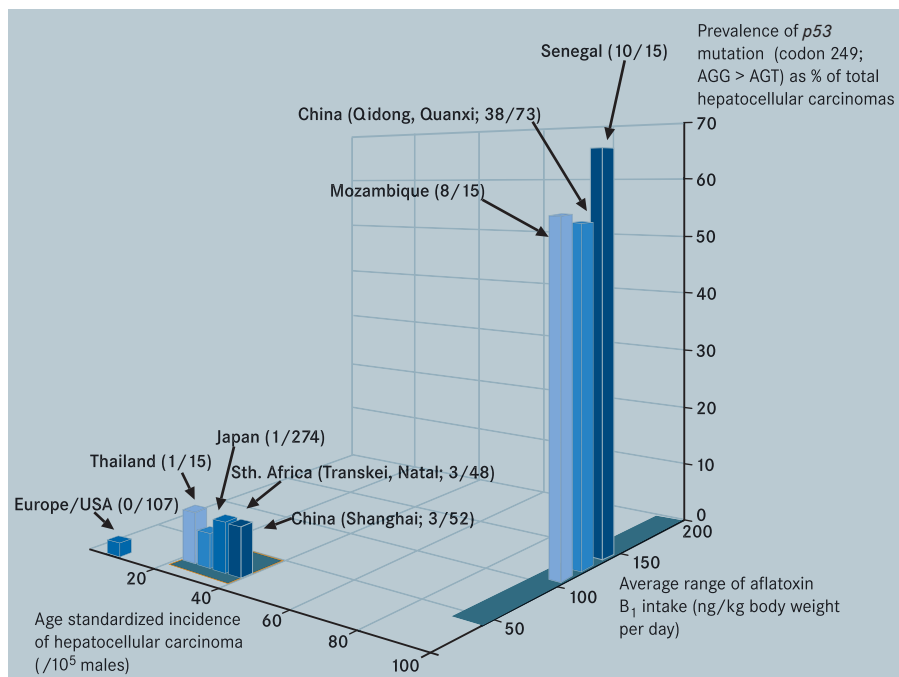

Fig. 2.30 Correlation between regional incidence of hepatocellular carcinoma, dietary exposure to aflatoxin B<sub>1</sub>, and prevalence of G>T mutations at codon 249 of the p53 tumour suppressor gene.

Polychlorinated dibenzo-*para*-dioxins (which include 2,3,7,8-tetrachlorodibenzo-*para*-dioxin, TCDD) are ubiquitous pollutants in soil sediments and air (*Environmental pollution*, p39). Human exposure occurs through eating meat and related foods. The burden of cancer attributable to such exposure is unknown [9].

### Chemicals generated during food preparation

Some chemicals formed during food preparation may present a carcinogenic hazard. The toxicity of these chemicals generally warrants the adoption of means to minimize their formation, particularly during industrialized food preparation. It has not been possible to attribute cancer causation in humans to hazards of this type specifically.

A possible pragmatic approach to the prioritization of chemical carcinogens occurring as food contaminants has been proposed. The highest priority category is chemical carcinogens that are believed to act by a genotoxic mechanism [10].

### Heterocyclic amines

Certain heterocyclic amines are formed by pyrolysis of two amino acids, creatine and creatinine, during cooking of meat and fish at high temperature. Heterocyclic amines are carcinogenic in various organs of mice, rats and non-human primates, although their carcinogenic potential in humans has not yet been established [11]. Metabolism of heterocyclic amines can vary between individuals due to various genetic polymorphisms.

### Polycyclic aromatic hydrocarbons

Polycyclic aromatic hydrocarbons can be generated in meat when it is fried, roasted or cooked over an open flame, and many members of this chemical class are carcinogenic. These compounds can also be formed during the curing and processing of raw foods prior to cooking. A number of polycyclic aromatic hydrocarbons, such as benzo[a]pyrene and benzanthracene, are present in smoke from the burning of fuels, tobacco and weeds.



Fig. 2.31 Nitrosamines are present in smoked fish consumed in many parts of the world, including the Gambia.

### N-Nitroso compounds

N-Nitroso compounds are a wide class of chemicals, many of which (particularly N-nitrosamines) are potent carcinogens in several species of experimental animals, and probably in humans [12]. Nitrosamines may be formed by chemical reactions in foods containing added nitrates and nitrites, such as salt-preserved fish and meat, and in foods processed by smoking or direct fire drying. The use of fertilizers may influence the level of nitrites in food, which may be a factor in determining generation of nitrosamines during food preparation and storage. Some industrial procedures, including brewing of beer, have been modified to reduce nitrosamine formation. Studies on volunteers consuming supplements of nitrate, or large portions of red meat, indicate that N-nitroso compounds can also be produced endogenously in the stomach and colon. Endogenous formation of nitrosamines is inhibited by several natural antioxidants, such as vitamins C and E, present in fruit and vegetables.

### Metals

The hazard presented by dietary metals, whether regarded as essential nutrients or contaminants, is difficult to assess [13].

## REFERENCES

1. Wild CP, Hall AJ (2000) Primary prevention of hepatocellular carcinoma in developing countries. *Mutat Res*, 462: 381-393.
2. Smela ME, Currier SS, Bailey EA, Essigmann JM (2001) The chemistry and biology of aflatoxin B(1): from mutational spectrometry to carcinogenesis. *Carcinogenesis*, 22: 535-545.
3. Montesano R, Hainaut P, Wild CP (1997) Hepatocellular carcinoma: from gene to public health. *J Natl Cancer Inst*, 89: 1844-1851.
4. IARC (1993) *Some Naturally Occurring Substances: Food Items and Constituents, Heterocyclic Aromatic Amines and Mycotoxins (IARC Monographs on the Evaluation of Carcinogenic Risks to Humans, Vol. 56)*, Lyon, IARC Press.
5. Castegnaro M, Plestina R, Dirheimer G, Chernozemsky IN, Bartsch H, eds (1991) *Mycotoxins, Endemic Nephropathy and Urinary Tract Tumours (IARC Scientific Publications, No. 115)*, Lyon, IARC Press.
6. Prakash AS, Pereira TN, Reilly PE, Seawright AA (1999) Pyrrolizidine alkaloids in human diet. *Mutat Res*, 443: 53-67.
7. Shahin M, Smith BL, Prakash AS (1999) Bracken carcinogens in the human diet. *Mutat Res*, 443: 69-79.
8. Department of Health (1999) Organochlorine insecticides and breast cancer. In: *1999 Annual Report of the Committees on Toxicity, Mutagenicity, Carcinogenicity of Chemicals in Food, Consumer Products and the Environment*, London, Department of Health (UK), 67-75.
9. van Leeuwen FX, Feeley M, Schrenk D, Larsen JC, Farland W, Younes M (2000) Dioxins: WHO's tolerable daily intake (TDI) revisited. *Chemosphere*, 40: 1095-1101.
10. McDonald AL, Fielder RJ, Diggle GE, Tennant DR, Fisher CE (1996) Carcinogens in food: priorities for regulatory action. *Hum Exp Toxicol*, 15: 739-746.
11. Layton DW, Bogen KT, Knize MG, Hatch FT, Johnson VM, Felton JS (1995) Cancer risk of heterocyclic amines in cooked foods: an analysis and implications for research. *Carcinogenesis*, 16: 39-52.
12. O'Neill IK, Chen J, Bartsch H, Dipple A, Shuker DEG, Kadlubar FF, Segerbäck D, Bartsch H, eds (1991) *Relevance to Human Cancer of N-Nitroso Compounds, Tobacco Smoke and Mycotoxins (IARC Scientific Publications, No. 105)*, Lyon, IARC Press.
13. Rojas E, Herrera LA, Poirier LA, Ostrosky-Wegman P (1999) Are metals dietary carcinogens? *Mutat Res*, 443: 157-181.

## WEBSITE

WHO Food Safety Programme:  
<http://www.who.int/fsf/index.htm>

# MEDICINAL DRUGS

## SUMMARY

- > Certain drugs used to treat malignant tumours, may rarely cause second primary tumours.
- > Drugs with hormonal activity or which block hormonal effects may increase risk of some hormonally-responsive cancers, while reducing the risk of others.
- > Drugs like diethylstilbestrol, which causes vaginal cancer following transplacental exposure, have been banned, while use of others, like phenacetin (which causes urothelial tumours), has been restricted.

Modern medicine has at its disposal hundreds of drugs, many of which are essential for the effective treatment of an enormous range of human diseases. A small fraction of such drugs has been found to have carcinogenicity to humans as a side-effect. This is most likely for some drugs that must be given at high doses or for prolonged periods. Where safer, non-carcinogenic alternatives exist, such drugs have been withdrawn from medical use. In certain cases, as in the treatment of otherwise fatal diseases such as disseminated cancer, the risk of using drugs that present a carcinogenic hazard is more than offset by an immediate benefit to the patient. Drugs that have been found to be carcinogenic to humans include some antineoplastic drugs and drug combinations [1], certain hormones and hormone antagonists [2,3], some immune suppressants and a small number of miscellaneous agents [1,4].

### Anti-cancer drugs

Some antineoplastic agents and combined drug therapies have caused secondary cancers in patients (Table 2.13).

These agents have been evaluated by the *IARC Monographs on the Evaluation of Carcinogenic Risks to Humans* as carcinogenic to humans (IARC Group 1). Some of them are no longer used in medicine because more effective and less hazardous drugs have become available. Other agents have properties similar to the known carcinogens, and are likely to be carcinogenic to humans (IARC Group 2A) (Table 2.14). These agents all have in common the ability either to react chemically with DNA to produce genetic damage at the cellular level (e.g. procarbazine), or to interfere with DNA replication in ways that can produce genetic damage (e.g. etoposide) (*Medical oncology*, p281). The agents in Table 2.13 that have been studied in animal experiments all cause tumours. The potential of many effective anti-tumour drugs to cause secondary cancers in treated patients is well recognized. Medical oncologists have devoted much effort to optimizing the doses of these drugs, in order to maximize the anti-tumour effects while minimizing risk of secondary cancers.

### Hormones

Hormones are potent regulators of bodily functions and hormonal imbalances can cause increased risk of certain cancers (*Reproductive factors and hormones*, p76). This can occur when natural or synthetic hormones are used for

medical purposes, as in certain contraceptive preparations and in post-menopausal hormonal therapies. Certain drugs have been developed that counteract the effects of certain hormones in specific tissues. Some of these drugs have hormone-like effects in other tissues, however, and can increase risk of cancer at these sites. Tamoxifen, for example, is an antiestrogen that may be given to women with estrogen receptor-positive breast tumours to block estrogen from entering the breast tissues. It is an effective drug for prevention of contralateral breast cancer in breast cancer patients, but it also increases risk of cancer of the endometrium [5]. Diethylstilbestrol is a synthetic estrogen, originally prescribed to prevent miscarriage, which caused malformations of the reproductive organs and is associated with increased risk of vaginal adenocarcinoma in daughters exposed to the drug *in utero* (Fig. 2.32).

### Other drugs and surgical implants

A small number of drugs that were used in medicine for many years for a variety of purposes other than antitumour, hormonal or immunosuppressive therapies have been found to present a risk of cancer in humans when used in very large quantities (e.g. phenacetin, contained in analgesic mixtures, Fig. 2.33) or for prolonged periods (e.g. Fowler's

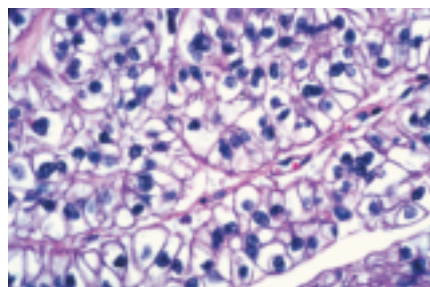

Fig. 2.32 Histopathology of a clear cell carcinoma of the vagina resulting from prenatal exposure to diethylstilbestrol.

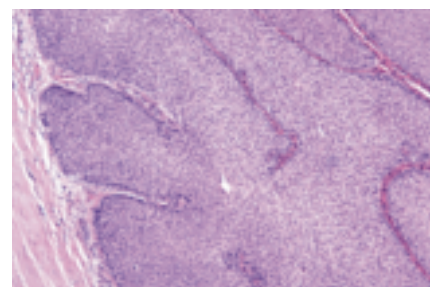

Fig. 2.33 Histopathology of a transitional cell carcinoma of the urinary tract caused by long-term abuse of phenacetin-based analgesics.

solution, containing a 1% solution of potassium arsenite in aqueous alcohol). The no-longer used radioactive X-ray contrast medium Thorotrast was associated with increased risk of angiosarcoma. Certain others have been found to be carcinogenic in experimental animals but have not been linked to cancers in humans despite extensive study. Some of these drugs have been withdrawn from clinical use (e.g. phenolphthalein), while others continue to be used because the benefit to individual patients is great and the risk of cancer is considered very slight (e.g. iron dextran, injectable; phenobarbital; phenytoin). Some drugs that have been recently introduced into human medicine, including the antiretroviral drugs zidovudine (AZT) and zalcitabine (ddC), are carcinogenic in experimental animals and may possibly be carcinogenic to humans (IARC Group 2B), although there is as yet no direct evidence of increased cancer risk in treated patients [6]. Surgical implants of various kinds are widely used for both therapeutic and cosmetic purposes [7]. Foreign bodies of many kinds cause development of malignant tumours of connective tissue (sarcomas) when implanted in tissues or body cavities of experimental rodents and left in place for long periods. Foreign bodies include both metallic and non-metallic solid objects, and non-absorbable or very slowly absorbable liquid suspensions. Sarcomas develop in rodents immediately adjacent to the foreign body, in the soft connective tissues or in bone and/or cartilage. There have been more than 60 published case reports of sarcomas and other kinds of cancers that have developed in humans at the sites of surgical implants or other foreign bodies. However, there are no controlled studies that would allow a conclusion that these cancers were indeed caused by the pre-existing foreign body. Female breast implants have been extensively studied, and for silicone implants there is evidence suggesting lack of carcinogenicity for breast carcinoma in women who have received these implants.

Drug or drug combination	Cancer site/cancer
<b>IARC Group 1</b>	
Analgesic mixtures containing phenacetin	Kidney, bladder
Azathioprine	Lymphoma, skin, liver and bile ducts, soft connective tissues
N,N-bis(2-chloroethyl)-2-naphthylamine (Chlornaphazine)	Bladder
1,4-Butanediol dimethane-sulfonate (Myleran; Busulfan)	Leukaemia
Chlorambucil	Leukaemia
1-(2-Chloroethyl)-3-(4-methyl-cyclohexyl)-1-nitrosourea (Methyl-CCNU)	Leukaemia
Ciclosporin	Lymphoma, Kaposi sarcoma
Cyclophosphamide	Leukaemia, bladder
Diethylstilbestrol	Cervix, vagina
Etoposide in combination with cisplatin and bleomycin	Leukaemia
Fowler's solution (inorganic arsenic)	Skin
Melphalan	Leukaemia
8-Methoxypsoralen (Methoxsalen) plus ultraviolet radiation	Skin
MOPP and other combined [anticancer] chemotherapy including alkylating agents	Leukaemia
Estrogen therapy, postmenopausal	Breast, uterus
Estrogens, non-steroidal	Cervix/vagina
Estrogens, steroidal	Uterus, breast
Oral contraceptives, combined <sup>a</sup>	Liver
Oral contraceptives, sequential	Uterus
Tamoxifen <sup>b</sup>	Uterus
Thiotepa	Leukaemia
Treosulfan	Leukaemia
<sup>a</sup> There is also conclusive evidence that these agents have a protective effect against cancers of the ovary and endometrium. <sup>b</sup> There is conclusive evidence that tamoxifen has a protective effect against second breast tumours in patients with breast cancer.	

Table 2.13 Medicinal drugs that are classified as being carcinogenic to humans (IARC Group 1).

Drug or drug combination	Cancer
<b>IARC Group 2A</b>	
Androgenic (anabolic) steroids	Liver cancer
Bis(chloroethyl) nitrosourea (BCNU)	Leukaemia
Chloramphenicol	Leukaemia
1-(2-Chloroethyl)-3-cyclohexyl-1-nitrosourea (CCNU)	Leukaemia
Etoposide	Leukaemia
5-Methoxypsoralen	Skin cancer
Nitrogen mustard	Skin cancer
Procarbazine hydrochloride	Leukaemia
Teniposide	Leukaemia

Table 2.14 Medicinal drugs that are probably carcinogenic to humans (IARC Group 2A).

The recent past has not been marked by major discoveries in relation to cancer causation by drugs. This situation is attributable, at least in part, to the vigilance imposed by national authorities in relation to preclinical and clinical drug testing. Putative drugs exhibiting activity in relevant carcinogen-screening tests are unlikely to be carried forward to final development and marketing. Consequently, the prevention of cancer attributable to medical treatment is not identified as a major public health need.

## REFERENCES

- Selbey JV, Friedman GD, Herrinton LJ (1996) Pharmaceuticals other than hormones. In: Schottenfeld D, Fraumeni, JF eds, *Cancer Epidemiology and Prevention*, New York, Oxford University Press, 489-501.
- Bernstein JF, Henderson BE (1996) Exogenous hormones. In: Schottenfeld D, Fraumeni, JF eds, *Cancer Epidemiology and Prevention*, New York, Oxford University Press, 462-488.
- IARC (1998) *Hormonal Contraception and Post-Menopausal Hormonal Therapy (IARC Monographs on the Evaluation of Carcinogenic Risks to Humans, Vol. 72)*, Lyon, IARCPress.
- IARC (1996) *Some Pharmaceutical Drugs (IARC Monographs on the Evaluation of Carcinogenic Risks to Humans, Vol. 66)*, Lyon, IARCPress.
- White IN (2001) Anti-oestrogenic drugs and endometrial cancers. *Toxicol Lett*, 120: 21-29.
- IARC (2000) *Some Antiviral and Antineoplastic Drugs and Other Pharmaceutical Agents (IARC Monographs on the Evaluation of Carcinogenic Risks to Humans, Vol. 76)*, Lyon, IARCPress.
- IARC (1999) *Surgical Implants and Other Foreign Bodies (IARC Monographs on the Evaluation of Carcinogenic Risks to Humans, Vol. 74)*, Lyon, IARCPress.

## WEBSITE

IARC Monographs programme, online search facility:  
<http://monographs.iarc.fr>



# RADIATION

## SUMMARY

- > Exposure to ionizing radiation from natural as well as from industrial, medical and other sources, can cause a variety of neoplasms, including leukaemia, breast cancer and thyroid cancer.
- > Sunlight is by far the most significant source of ultraviolet irradiation and causes several types of skin cancer, particularly in highly-exposed populations with fair skin, e.g. Australians of Caucasian origin.
- > Extremely low frequency electromagnetic fields generated by electrical power transmission have been associated with an increased risk of childhood leukaemia, but the findings are not conclusive.

Natural and man-made sources generate radiant energy in the form of electromagnetic waves. Their interaction with biological systems is principally understood at the cellular level. Electromagnetic waves are characterized by their wavelength, frequency, or energy. Effects on biological systems are determined by the intensity of the radiation, the energy in each photon and the amount of energy absorbed by the exposed tissue.

The electromagnetic spectrum extends from waves at low frequency (low energy), referred to as “electric and magnetic fields”, to those at very high frequencies, which are often called “electromagnetic radiation” (Fig. 2.38). The highest-energy electromagnetic radiation is X- and  $\gamma$ -radiation, which have sufficient photon energy to produce ionization (i.e. create positive and negative electrically-charged atoms or parts of molecules) and thereby break chemical bonds. Other forms of ionizing radiation are the sub-atomic particles (neutrons, electrons ( $\beta$ -particles) and  $\alpha$ -particles) that make up cosmic rays and

are also emitted by radioactive atoms. Non-ionizing radiation is a general term for that part of the electromagnetic spectrum which has photon energies too weak to break chemical bonds, and includes ultraviolet radiation, visible light, infrared radiation, radiofrequency and microwave fields, extremely low frequency (ELF) fields, as well as static electric and magnetic fields.

## Ionizing radiation

Exposure to ionizing radiation is unavoidable [1]. Humans are exposed both to X-rays and  $\gamma$ -rays from natural sources (including cosmic radiation and radioactivity present in rocks and soil) and, typically to a much lower extent, from man-made sources (Fig. 2.35). On average, for a member of the general public, the greatest contribution comes from medical X-rays and the use of radiopharmaceuticals, with lower doses from fallout from weapons testing, nuclear accidents (such as Chernobyl), and accidental and routine releases from nuclear installations. Medical exposures occur both in the diagnosis (e.g. radiography) of diseases and injuries and in the treatment (e.g. radiotherapy) of cancer and of some benign diseases. Occupational

exposure to ionizing radiation occurs in a number of jobs, including the nuclear industry and medicine. Airline pilots and crew are exposed to cosmic radiation.

## Cancer causation

Ionizing radiation is one of the most intensely studied carcinogens [2-4].



Fig. 2.34 Modern diagnostic radiology is no longer a significant source of exposure to ionizing radiation.

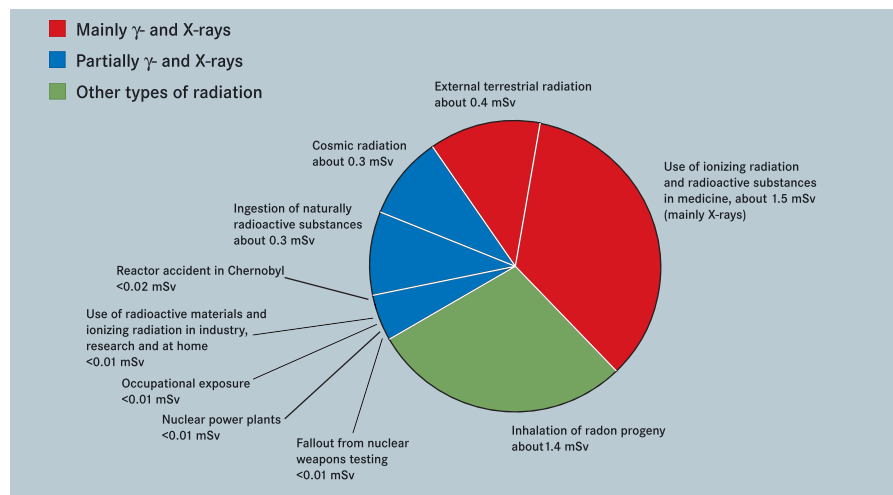

Fig. 2.35 Estimated annual dose of ionizing radiation received by a member of the general public.

Agent or substance	Cancer site/cancer
<b>IARC Group 1: Carcinogenic to humans</b>	
X-rays and gamma-radiation	Various – all sites
Solar radiation	Skin
Radon-222 and its decay products	Lung
Radium-224, -226, -228 and their decay products	Bone
Thorium-232 and its decay products	Liver, including haemangiosarcoma; leukaemia
Radioiodines (including iodine-131)	Thyroid
Plutonium-239 and its decay products (aerosols)	Lung, liver, bone
Phosphorus-32	Leukaemia
Neutrons	Various
Alpha ( $\alpha$ ) particle-emitting radionuclides	Various
Beta ( $\beta$ ) particle-emitting radionuclides	Various
<b>IARC Group 2A: Probably carcinogenic to humans</b>	
Sunlamps and sun beds, use of	Skin
Ultraviolet radiation	Skin

Table 2.15 Various forms and sources of radiation that are carcinogenic to humans (IARC Group 1) or probably carcinogenic to humans (IARC Group 2A).

Frequency	Class	Type of device or service
30 - 300 kHz	LF (low)	LF broadcast and long-range radio
300 - 3,000 kHz	MF (medium)	AM radio, radio navigation, ship-to-shore
3 - 30 MHz	HF (high)	CB radio, amateurs, HF radio communications and broadcast
30 - 300 MHz	VHF (very high)	FM radio, VHF TV, emergency services
300 - 3,000 MHz	UHF (ultra high)	UHF TV, paging, mobile telephones, amateur radios
3 - 30 GHz	SHF (super high)	Microwaves, satellite communications, radar, point to point microwave communications
30 - 300 GHz	EHF (extremely high)	Radar, radioastronomy, short-link microwave communications

Table 2.16 Radiofrequency range: class and type of device or service.



Fig. 2.36 The Chernobyl nuclear power plant following the accident in 1986.

Knowledge of associated health effects comes from epidemiological study of hundreds of thousands of exposed persons, including the survivors of the atomic bombings in Hiroshima and Nagasaki, patients irradiated for therapeutic purposes, populations with occupational exposures and people exposed as a result of accidents. These data are complemented by findings from large-scale animal experiments carried out to evaluate the effects of different types of radiation, taking account of variation in dose and exposure pattern, and with reference to cellular and molecular endpoints. Such experiments are designed to characterize the mechanisms of radiation damage, repair and carcinogenesis.

Survivors of the atomic bombings in Hiroshima and Nagasaki were exposed primarily to  $\gamma$ -rays. Amongst these people, dose-related increases in the risk of leukaemia, breast cancer, thyroid cancer and a number of other malignancies have been observed. Increased frequency of these same malignancies has also been observed among cancer patients treated with X-rays or  $\gamma$ -rays. The level of cancer risk after exposure to X-rays or  $\gamma$ -rays is modified by a number of factors in addition to radiation dose, and these include the age at which exposure occurs, the length of time over which radiation is received and the sex of the exposed person. Exposure to high-dose radiation increases the risk of leukaemia by over five-fold. Even higher relative risks have been reported for thyroid cancer following irradiation during childhood.



Fig. 2.37 Deliberate exposure to solar radiation in order to achieve a sun-tan.

Internalized radionuclides that emit  $\alpha$ -particles and  $\beta$ -particles are carcinogenic to humans. For most people, exposure to ionizing radiation from inhaled and tissue-deposited radionuclides is mainly from naturally-occurring radon-222. Exposure to thorium-232, which occurs in soil, is less common. Cancers associated with exposure to particular nuclides, usually in an occupational context, include lung cancer, bone sarcomas, liver cancer, leukaemia and thyroid cancer.

The United Nations Scientific Committee on the Effects of Atomic Radiation [5] has estimated the lifetime risk of solid cancers and of leukaemia following an acute

whole-body exposure to  $\gamma$  radiation, together with the corresponding estimated numbers of years of life lost per radiation-induced case (Table 2.17). The current recommendations of the International Commission for Radiological Protection are to limit exposures to the general public to 1 mSv per year, and doses to workers to 100 mSv over 5 years [6] (1 Sievert equals 1 joule per kilogram).

### Ultraviolet radiation

The major source of human exposure to ultraviolet radiation is sunlight. Approximately 5% of the total solar radiation received at the surface of the earth is ultraviolet [7]. Intensity of solar terrestrial radiation varies according to geography, the time of day and other factors. The level of skin exposure to sunlight depends on many parameters including cultural and social behaviour, clothing, the position of the sun and the position of the body. Few measurements of personal exposure have been reported. Artificial sources of ultraviolet radiation are common and such devices are used to treat a number of diseases (e.g. psoriasis) as well as for cosmetic purposes.

### Cancer causation

Solar radiation, and specifically the ultraviolet component of it, causes cutaneous malignant melanoma and non-melanocytic skin cancer (Fig. 2.39). Exposure of skin to ultraviolet radiation causes DNA damage (*Carcinogen activation and DNA repair*, p89) and also the conversion of *trans*-urocanic acid to *cis*-urocanic acid, which leads to cell injury and ultimately to cancer. Incidence of skin cancer is increasing rapidly among fair-skinned populations [7] (*Melanoma*, p253). In Canada, for example, occurrence of this disease has doubled over the past 25 years. IARC has estimated that at least 80% of all melanomas are caused by exposure to sunlight. Non-melanocytic skin cancer, which includes basal cell carcinoma and squamous cell carcinoma, is the most prevalent human malignancy: more people are living with this cancer than any other. In the USA and Australia, one of every two new cancers diagnosed is a non-melanocytic skin cancer. Use of sun-lamps and sunbeds probably causes skin melanomas in humans.

### Electromagnetic fields

Recent years have seen an unprecedented increase in the number and diversity of

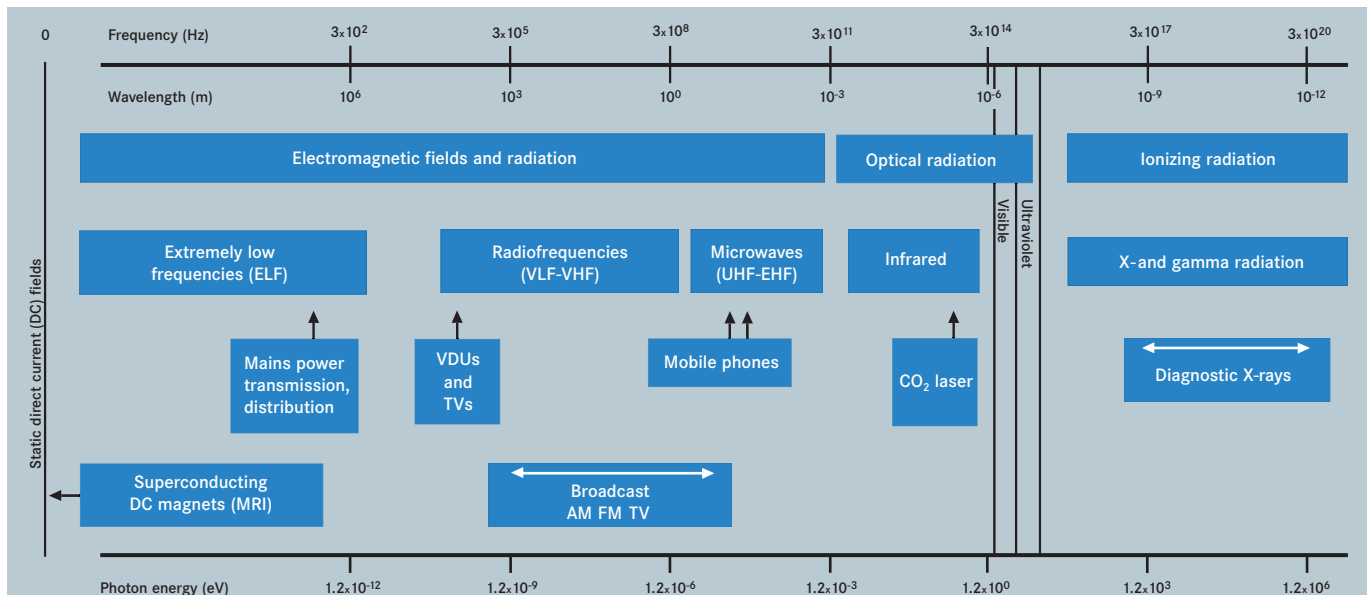

Fig. 2.38 The spectrum of electromagnetic fields and their use in daily life.

	Lifetime risk		Number of years of life lost per case	
	0.2 Sv	1 Sv	0.2 Sv	1 Sv
<b>Solid cancers</b>	2.4%	10.9%	11.2	11.6
<b>Leukaemia</b>	0.14%	1.1%	31	31

Table 2.17 Estimated risk of cancer following acute whole-body exposure to gamma radiation at two dose levels.

sources of electromagnetic fields [8], principally extremely low frequency and radiofrequency fields. Such sources include all equipment using electricity, television, radio, computers, mobile telephones, microwave ovens, anti-theft gates in large shops, radars and equipment used in industry, medicine and commerce. Static fields and extremely low frequency fields occur naturally, and also arise as a consequence of the generation and transmission of electrical power and through

the operation of a range of industrial devices and domestic appliances, the latter often at a greater field intensity. Exposure to extremely low frequency fields is mainly from human-made sources for the generation, transmission and use of electricity. Occupational exposure occurs, for example, in the electric and electronics industry, in welding and in use and repair of electrical motors. Environmental exposure to extremely low frequency fields occurs in residential settings due to prox-

imity to electricity transmission lines and use of electric appliances. Levels of exposure from many environmental sources are typically low [9].

Exposure to radiofrequency radiation can occur in a number of ways. The primary natural source of radiofrequency fields is the sun. Man-made sources, however, are the main source of exposure. Radiofrequency fields are generated as a consequence of commercial radio and television broadcasting and from telecommunications facilities (Table 2.16). Radiofrequency fields in the home are generated by microwave ovens and burglar alarms. Mobile telephones are now, however, the greatest source of radiofrequency exposure for the general public.

In respect of the work environment, employees working in close proximity to radiofrequency-emitting systems may receive high levels of exposure. This includes workers in the broadcasting, transport and communication industries, and in antenna repair, military personnel (e.g. radar operators) and police officers (utilizing traffic control radars). There are also industrial processes that use radiofrequency fields and these include dielectric heaters for wood lamination and sealing of plastics, industrial induction heaters and microwave ovens, medical diathermy equipment to treat pain and inflammation of body tissues, and electro-surgical devices for cutting and welding tissues.

#### Cancer causation

Several expert groups have recently reviewed the scientific evidence concerning the carcinogenicity of extremely low frequency fields e.g. [9,10]. A number of epidemiological studies on childhood leukaemia indicate a possible relationship between risk and exposure to extremely low frequency fields. Studies of adult cancers following occupational or environmental exposures to extremely low frequency fields are much less clear. There is little experimental evidence that these fields can cause mutations in cells. Mechanistic studies and animal experiments do not show any consistent positive

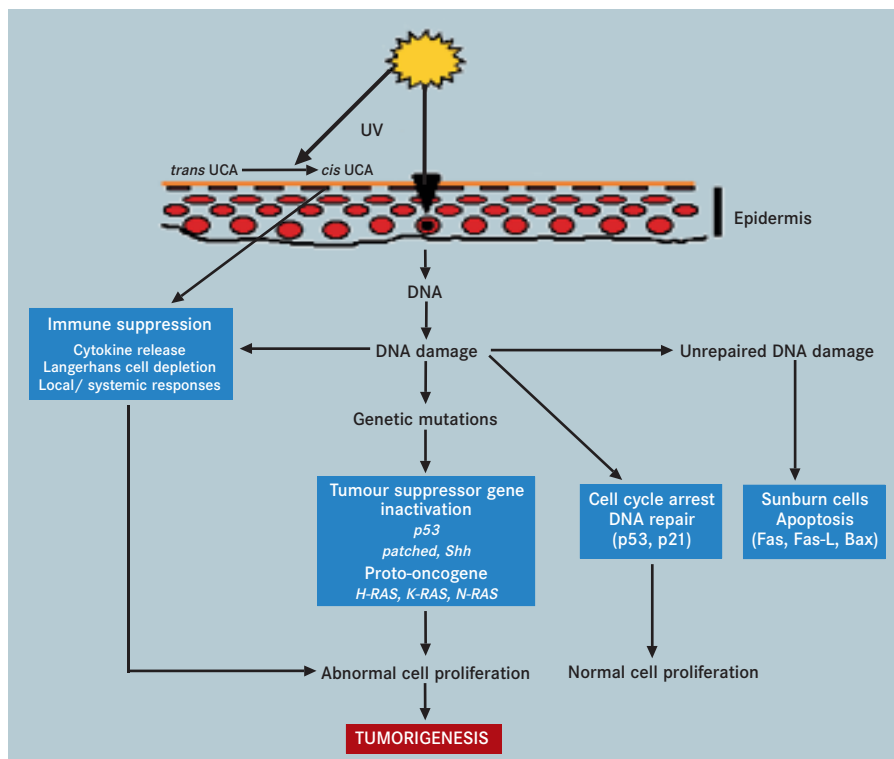

Fig. 2.39 Pathways implicated in the induction of non-melanoma skin cancer by ultraviolet radiation (UCA = urocanic acid).

results, although sporadic findings concerning biological effects (including increased cancers in animals) have been reported. IARC has classified extremely low frequency fields as possibly causing cancer in humans (Group 2B), based on childhood leukaemia findings [10]. The evidence for the carcinogenicity of radiofrequency fields is even less clear [11-14]. A few epidemiological studies in occupational settings have indicated a possible increase in the risk of leukaemia or brain tumours, while other studies indicated decreases. These studies suffer from a number of limitations. The experimental evidence is also limited, but suggests that radiofrequency fields cannot cause DNA mutations. The lack of reproducibility of findings limits the conclusions that can be drawn.



Fig. 2.40 Satellite-based analyses (1996) demonstrate increases in average annual levels of ultraviolet B (UVB) radiation reaching the Earth's surface over the past ten years. These changes are strongly dependent on latitude.

## REFERENCES

1. IARC (2000) *Ionizing Radiation, Part 1: X- and Gamma Radiation and Neutrons (IARC Monographs on the Evaluation of Carcinogenic Risks to Humans, Vol. 75)*, Lyon, IARC Press.
2. United Nations Scientific Committee on the Effects of Atomic Radiation (2000) *Sources and Effects of Ionizing Radiation: 2000 Report*, Vienna, UNSCEAR.
3. US National Academy of Sciences (1998) *Health Effects of Radon and Other Internally Deposited Alpha-Emitters (US NAS, BEIR VI Report)*, Washington DC, US National Academy of Sciences.
4. US National Academy of Sciences (1990) *Health Effects on Populations of Exposure to Low Levels of Ionizing Radiation (US NAS BEIR V Report)*, Washington DC, US National Academy of Sciences.
5. United Nations Scientific Committee on the Effects of Atomic Radiation (1994) *Sources and Effects of Ionizing Radiation: 1994 Report*, Vienna, UNSCEAR.
6. International Commission on Radiological Protection (1991) *Recommendations of the International Commission on Radiological Protection (ICRP Report 60)*, Oxford, Pergamon Press.
7. IARC (1992) *UV and Solar Radiation (IARC Monographs on the Evaluation of Carcinogenic Risks to Humans, Vol. 55)*, Lyon, IARC Press.
8. Bernhardt JH, Matthes R, Repacholi M, eds (1997) *Non-Thermal Effects of RF Electromagnetic Fields (International Commission on Non-Ionizing Radiation Protection, WHO)*, Geneva, World Health Organization.
9. Bernhardt JH, Matthes R, Repacholi M, eds (1998) *Static and Extremely Low Frequency Electric and Magnetic*

*Fields (International Commission on Non-Ionizing Radiation Protection, WHO)*, Geneva, World Health Organization.

10. US National Institute for Environmental Health Sciences (1999) *Report of the EMF-Rapid Programme*, NIEHS.
11. McKinlay A (1997) A possible health effect related to the use of radiotelephones. *Radiological Protection Bull*, 187: 9-16.
12. Repacholi MH (1998) Low-level exposure to radiofrequency electromagnetic fields: health effects and research needs. *Bioelectromagnetics*, 19: 1-19.
13. Royal Society of Canada (2000) *A Review of the Potential Health Risks of Radiofrequency Fields from Wireless Telecommunication Devices (RSC.EPR 1999-1)*, Ottawa, Royal Society of Canada.
14. Independent Expert Group on Mobile Phones (2000) *Mobile Phones and Health*, National Radiological Protection Board.

## WEBSITES

- ICNIRP (International Commission for Non-ionizing Radiation Protection):  
<http://www.icnirp.de>
- National Council on Radiation Protection and Measurements (NCRP), USA:  
<http://www.ncrp.com>
- National Radiological Protection Board (NRPB), UK:  
<http://www.nrpb.org.uk>
- National Academy of Sciences USA, Committee on the Biological Effects of Ionizing Radiation (BEIR):  
<http://www.nas.edu>
- Radiation Effects Research Foundation (RERF), Hiroshima, Japan:  
<http://www.rerf.or.jp>
- WHO International EMF Project:  
<http://www.who.int/peh-emf/>
- US National Institute for Environmental Health Sciences (NIEHS) report of EMF-rapid programme, 1998:  
[http://www.niehs.nih.gov/emfrapid/html/EMF\\_DIR\\_RPT/staff\\_18f.htm](http://www.niehs.nih.gov/emfrapid/html/EMF_DIR_RPT/staff_18f.htm)
- US National Research Council report: Possible Health Effects of Exposure to Residential Electric and Magnetic Fields (1997):  
<http://books.nap.edu/books/0309054478/html>
- The Stewart report: Independent Expert Group on Mobile Phones: Report on Mobile Phones and Health, 2000, UK:  
<http://www.iegmp.org.uk/report/index.htm>
- The Royal Society of Canada report, 1999:  
<http://www.rsc.ca/english/RFreport.pdf>



# CHRONIC INFECTIONS

## SUMMARY

- > Infectious agents are one of the main causes of cancer, accounting for 18% of cases worldwide, the majority occurring in developing countries.
- > The most frequently affected organ sites are liver (hepatitis B and C, liver flukes), cervix uteri (human papillomaviruses), lymphoid tissues (Epstein-Barr virus), stomach (*Helicobacter pylori*) and the urinary system (*Schistosoma haematobium*).
- > The mechanism of carcinogenicity by infectious agents may be direct, e.g. mediated by oncogenic proteins produced by the agent (e.g. human papillomavirus) or indirect, through causing of chronic inflammation with tissue necrosis and regeneration.
- > Strategies for prevention include vaccination (hepatitis B virus), early detection (cervical cancer) and eradication of the infectious agent (*Helicobacter pylori*).

## Infectious agents can cause cancer

That cancer can be caused by infectious agents has been known for more than 100 years. Early in the last century, Peyton Rous demonstrated that sarcomas in chickens were caused by an infectious agent, later identified as a virus [1]. However, the identification of infectious agents linked to human cancer has been slow, in part because of difficulties in detecting indicators of exposure. Progress has accelerated since the 1980s when advances in molecular biology made possible the detection of a very small quantity of infectious agent in biological specimens. A further difficulty is the fact that relevant infectious agents tend to persist silently for many years, before causing cancer in only a small proportion of chronically infected individuals.

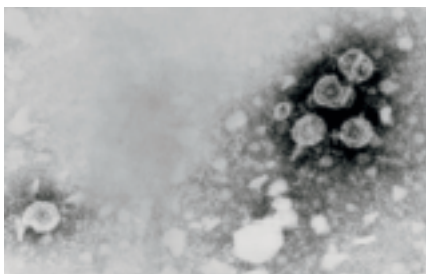

Fig. 2.41 Electron microscopy of hepatitis B virus particles.

Today, experimental and epidemiological evidence indicates that a variety of infectious agents constitute one of the main causes of cancer worldwide [2]. Viruses are the principal ones, with at least eight different viruses associated with particular tumour types, with varying degrees of certainty. Other infectious agents involved in carcinogenesis are four parasites and one bacterium [3-7] (Table 2.18).

### Hepatitis B and C viruses

Worldwide, about 2,000 million people have serological evidence of current or past hepatitis B virus (HBV) infection and about 350 million of them are chronic carriers of the virus. Infection can be transmitted from mother to child (vertical transmission), child to child (horizontal transmission), through sexual transmission and by contact with infected blood. Horizontal transmission is responsible for the majority of infections in the world, although the exact mechanisms of child to child transmission remain unknown. Close contact of young children is the primary risk factor and exposure to skin lesions, sharing food and utensils, tattooing and scarification procedures, and transmission by insects are some of the postulated mechanisms. The use of contaminated needles for medically-related injections may have played a role, probably via therapeutic injections rather than vaccination. Several case-control and cohort studies have clearly and consistently demonstrat-

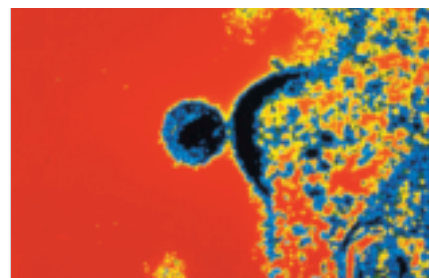

Fig. 2.42 The human immunodeficiency virus finds refuge in T-lymphocytes, as shown by the electron micrograph.

ed that chronic carriers of HBV, identified by the presence of relevant antibodies in the sera, have around a 20 times higher risk of developing liver cancer than non-carriers [3]. It has been estimated that 60% of cases of primary liver cancer worldwide and 67% of cases in developing countries can be attributed to chronic persistent infection with HBV [2]. In many situations, exposure to aflatoxins is a related risk factor (*Food contaminants*, p43). Hepatitis C virus (HCV) is the major cause of parenterally transmitted hepatitis worldwide. Strong associations with relative risks around 20 have been reported in several case-control studies. About 25% of cases of liver cancer in the world are attributable to HCV [3].

### Human papillomavirus

Over 100 human papillomavirus (HPV) types have been identified and about 30 are known to infect the genital tract. Genital HPV types are subdivided into low-risk (e.g. 6 and 11) and high-risk or oncogenic types (e.g. 16, 18, 31 and 45) [5]. Dozens of molecular epidemiological studies [5, 8, 9] have consistently shown relative risks for invasive cervical cancer ranging from 20 to over 100. In fact, HPV DNA is found in virtually all invasive cervical cancers, indicating that HPV is a necessary cause [10] (*Cancers of the female reproductive tract*, p215). Moreover, about 80% of anal cancers and 30% of cancers of the vulva, vagina, penis

Infectious agent	IARC classification <sup>1</sup>	Cancer site/cancer	Number of cancer cases	% of cancer cases worldwide
<i>H. pylori</i>	1	Stomach	490,000	5.4
HPV	1, 2A	Cervix and other sites	550,000	6.1
HBV, HCV	1	Liver	390,000	4.3
EBV	1	Lymphomas and nasopharyngeal carcinoma	99,000	1.1
HHV-8	2A	Kaposi sarcoma	54,000	0.6
<i>Schistosoma haematobium</i>	1	Bladder	9,000	0.1
HTLV-1	1	Leukaemia	2,700	0.1
Liver flukes <i>Opisthorchis viverrini</i> <i>Clonorchis sinensis</i>	1 2A	Cholangiocarcinoma (biliary system)	800	
		Total infection-related cancers	1,600,000	17.7
		Total cancers in 1995	9,000,000	100

**Table 2.18** The burden of cancer caused by infectious agents worldwide. <sup>1</sup>Group 1= carcinogenic to humans, Group 2A= probably carcinogenic to humans. <sup>2</sup>Applies only to cervical cancer.

and oro-pharynx can be attributed to HPV.

#### *Epstein-Barr virus*

Epstein-Barr virus (EBV) infection is ubiquitous. In developing countries, infection is acquired in childhood, while in developed countries infection is delayed until adolescence [7]. Individuals with high titres of antibodies to various early and late EBV antigens have a higher risk of developing Burkitt lymphoma and Hodgkin disease (*Lymphoma*, p237). Molecular evidence showing that EBV DNA and viral products are regularly detected (monoclonally) in cancer cells, but not in normal cells, provides a strong indication of a causal role for EBV in nasopharyngeal carcinoma and sinonasal angiocentric T-cell lymphoma. The association of EBV is associated with non-Hodgkin lymphoma mainly in patients with congenital or acquired immunodeficiency [7].

#### *Human immunodeficiency virus*

The prevalence of human immunodeficiency virus (HIV) infection is highest in sub-Saharan Africa (15-20%). High levels of infection are also seen among homosexual men, intravenous drug users and in subjects transfused with HIV-infected blood. An estimated 36 million people worldwide are currently living with HIV, and some 20 million people have died as a result of HIV-related disease [11]. HIV infection enhances the risk of Kaposi sarcoma by approximately 1,000-fold, of non-Hodgkin lymphoma by 100-fold, and of Hodgkin disease by 10-fold [6] (Box: *Tumours associated with HIV/AIDS*, p60). Increased risk of cancer of the anus, cervix and conjunctiva has also been observed. In all these cases, the role of HIV is probably as an immunosuppressive agent (*Immunosuppression*, p68) and hence indirect, the direct etiological agents being other cancer viruses (i.e. human herpesvirus 8 (HHV-8), EBV and HPV) [5-7].

#### *Human T-cell lymphotropic virus*

Human T-cell lymphotropic virus (HTLV-1) infection occurs in clusters in Japan, Africa, the Caribbean, Colombia and Melanesia [6]. As many as 20 million people worldwide may be infected with this virus. Spread of the virus is thought to occur from mother to child (mainly through breast-feeding beyond six months), via sexual transmission and as a result of transfusion of blood cell products, as well as through intravenous drug use. A strong geographical correlation suggests that HTLV-1 is the main etiological factor in adult T-cell leukaemia/lymphoma. This disease occurs almost exclusively in areas where HTLV-1 is endemic. In addition, laboratory evidence shows that the virus is clonally integrated into tumour cells. An association with tumours of the cervix, vagina and liver has been reported, but effects of confounding and bias cannot be excluded [6].

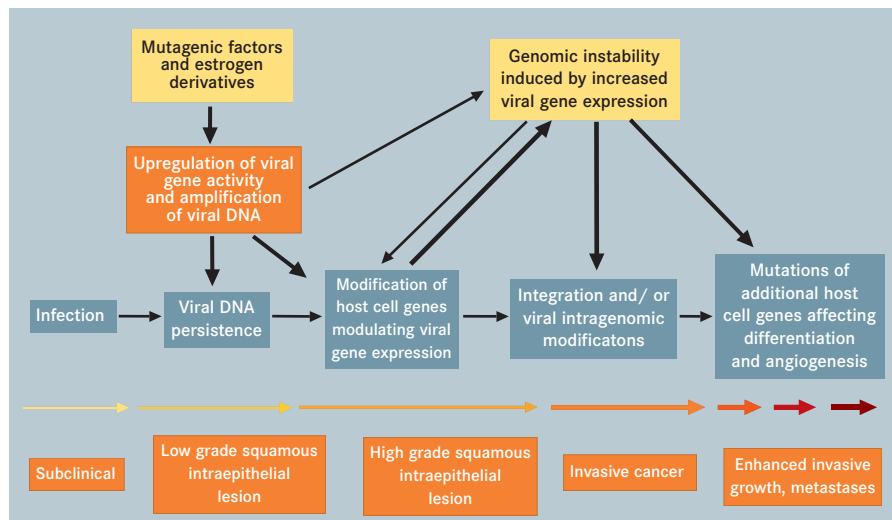

Fig. 2.43 Proposed pathogenetic mechanism by which human papillomavirus infection causes cervical cancer. Adapted from H zur Hausen, *Virology* 184, 9-13 (1991).

### Human herpes virus 8

Human herpesvirus 8 (HHV-8) infection appears to be common in Africa and in some Mediterranean countries but rare elsewhere. HHV-8 DNA has been detected in over 90% of Kaposi sarcomas and rarely in control patients. Seropositivity rates are also higher in cases than controls, with relative risks over 10 in most studies. Accordingly, the evidence linking HHV-8 to Kaposi sarcoma is strong [9]. Certain lymphoproliferative diseases such as primary effusion lymphoma and Castleman disease have also been linked to HHV-8, but the evidence is very limited [7].

### *Helicobacter pylori*

Infection with *Helicobacter pylori* is one of the most common bacterial infections worldwide. In developing countries, the prevalence of *H. pylori* among adults ranges from 80 to 90% whilst in developed areas it is around 50%. *H. pylori* is the main cause of gastritis and peptic ulcer; infection may be lifelong if not treated with antibiotics [12]. The relationship between gastric cancer and *H. pylori* has been difficult to determine due to the very high prevalence of *H. pylori* in most populations where the cancer is endemic and the very low bacterial load usually found in gastric cancer patients. It is clear that *H.*

*pylori* plays a role in gastric cancer, but other cofactors (e.g. diet) are also contributory (*Stomach cancer*, p194).

### Parasites

Two liver flukes, *Opisthorchis viverrini* and *Clonorchis sinensis*, have been associated with cholangiocarcinoma in parts of Asia (*Liver cancer*, p203). Infection by these flukes is acquired by eating raw or undercooked freshwater fish containing the infective stage of the fluke; the fluke matures and produces eggs in the small intrahepatic ducts [4]. The evidence for cancer causation by *O. viverrini*, a parasite mainly prevalent in Thailand, is stronger than for *C. sinensis*. The incidence of cholangiocarcinoma in areas where these liver flukes are non-endemic is very low. Schistosomes are trematode worms. The cercarial stage infects humans by skin penetration. The worms mature and lay eggs in the bladder or intestine of the host, provoking symptoms of a disease known as bilharzia. *Schistosoma haematobium* infection is prevalent in Africa and the Middle East and has been identified as a cause of bladder cancer. *Schistosoma japonicum* infection is prevalent in Japan and China and has been associated with cancers of the liver, stomach and colorectum, but the evidence is weak and inconsistent [4].



Fig. 2.44 Processing samples for HPV testing as part of a study of HPV prevalence in Thailand.



Fig. 2.45 The *Helicobacter pylori* bacterium structure as revealed by scanning electron microscopy.

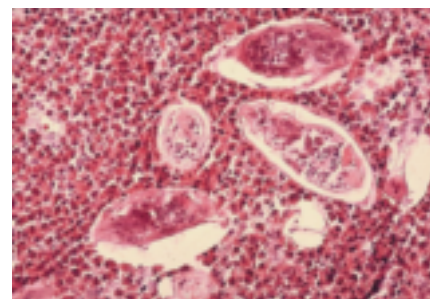

Fig. 2.46 Chronic infection of the bladder with *Schistosoma haematobium* causes an inflammatory reaction with dense eosinophilic infiltrates which may cause the development of a squamous cell carcinoma.

### Mechanisms of carcinogenicity

Two main pathogenic mechanisms have been invoked for infectious agents associated with cancer [13]. The first is a direct effect, when agents act directly on the cells which are ultimately transformed. HPV-induced cancer of the cervix is the best understood example of a “direct” effect in humans. The E5 oncoprotein expressed by high-risk HPV types may play a role in the early growth stimulation of

infected cells, whilst oncoproteins E6 and E7 interfere with the functions of negative cellular regulators, including p53 and pRb (*Oncogenes and tumour suppressor genes*, p96). Integration of the viral genome, deregulation of oncogene expression and other cofactors may all contribute to malignant progression (Fig. 2.43).

A few other viruses are directly linked to human cancer, including EBV, HTLV-1 and HHV-8. EBV infects B lymphocytes and expression of viral protein is believed to induce what would otherwise be antigen-driven lymphocyte activation. The immortalization-associated viral proteins regulate the maintenance of the episomal viral DNA and the expression of viral genes, as

well as driving cellular proliferation and blocking apoptosis. It is believed that a crucial role in the transformation and immortalization of infected cells is played by the EBNA-2 protein. Malarial infection may be a cofactor in the progression of Burkitt lymphoma. HTLV-1 is able to immortalize human T lymphocytes *in vitro*. Central to this property is the HTLV-1 Tax protein which, via interference with several classes of transcription factors, activates the expression of some cellular genes involved in the control of cellular proliferation. HHV-8 is the most recently-identified tumour-causing virus and its role in pathogenesis is still poorly understood [7, 13].

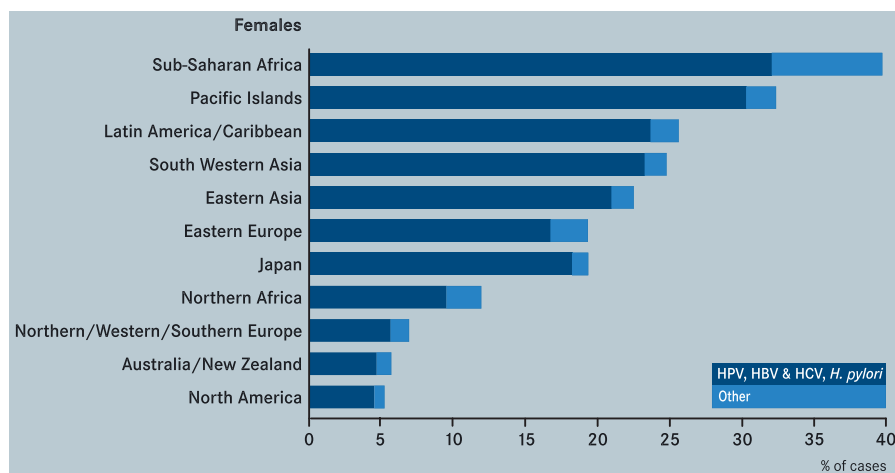

Fig. 2.47 The burden of cancer caused by infectious agents in women.

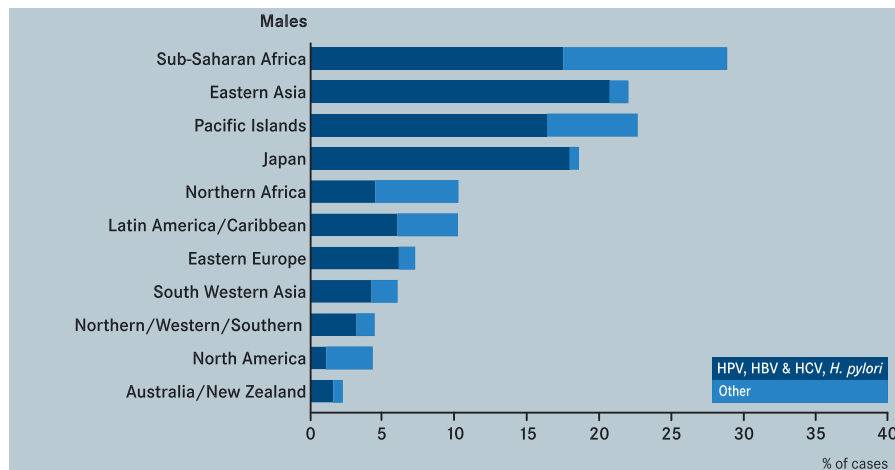

Fig. 2.48 The burden of cancer caused by infectious agents in men.

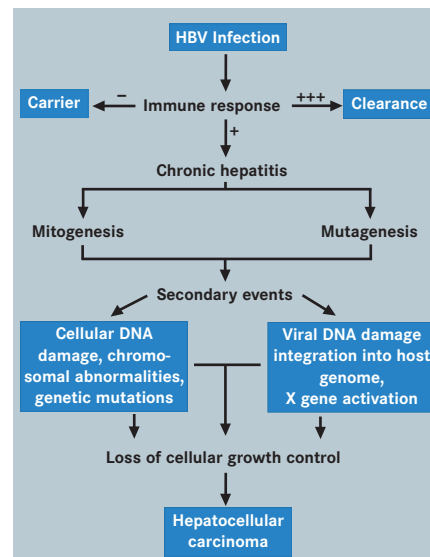

Fig. 2.49 Hepatitis B virus and the chronic injury hypothesis. A vigorous immune response to hepatitis B virus (+++) leads to viral clearance while an absent immune response (-) leads to the “healthy” carrier state and an intermediate response (+) produces chronic hepatitis which, via a multistep process, may eventually lead to hepatocellular carcinoma.

The second, or indirect, mechanism is the mode of action for some viruses (HBV, HCV, HIV), bacteria (*H. pylori*) and parasites. These agents provoke cancer by causing chronic inflammation and/or production of mutagenic compounds. The hepatitis viruses, for example, are unable to immortalize human cells *in vitro*, but infection may lead to cancer via induction of chronic liver injury and hepatitis (Fig. 2.49). Chronic hepatitis caused by an intermediate immune response to HBV infection is characterized by chronic liver cell necrosis which stimulates a sustained regenerative response. The inflammatory component includes activated macrophages which are a rich source of free radicals. The collaboration of these mitogenic and mutagenic stimuli has the potential to cause cellular and viral DNA damage, chromosomal abnormalities and genetic mutations that deregulate cellular growth control in a multistep process that eventually leads to hepatocellular carcinoma.

A prolonged process, lasting decades, precedes emergence of most gastric cancers. *H. pylori* is the most frequent cause of chronic gastritis. Gastritis and atrophy



## TUMOURS ASSOCIATED WITH HIV/AIDS

Approximately 30-40% of patients with HIV infection are likely to develop malignancies.

*Kaposi sarcoma* is the most common malignancy in patients with HIV infection. Since no current therapies have proven curative, both delivery of effective treatment and maintenance of adequate control of HIV and other infections remain the goals of current treatment. Several studies have shown benefits of highly active anti-retroviral treatment (HAART) on Kaposi sarcoma lesions. HAART might be a useful alternative both to immune response modifiers during less aggressive stages of this disease and to systemic cytotoxic drugs in the long term maintenance therapy of advanced Kaposi sarcoma (Tavio M et al., *Ann Oncol*, 9: 923, 1998; Tirelli U and Bernardi D, *Eur J Cancer*, 37: 1320-24, 2001). Liposomal anthracyclines are considered the standard treatment for patients with advanced stages of AIDS-related Kaposi sarcoma. Concomitant use of both HAART and haematological growth factors is needed, with the aim of reducing opportunistic infections and myelotoxicity.

*Non-Hodgkin lymphoma* in patients with HIV infection is about two hundred-fold more frequent than expected. One feature of AIDS-non-Hodgkin lymphoma is the widespread extent of the disease at initial presentation and the frequency of systemic B-symptoms (general symptoms such as night sweats, weight loss, temperature change). Whether intensive or conservative chemotherapy regimens are appropriate is still a matter of controver-

sy. In fact, the poor bone marrow reserve and underlying HIV immunodeficiency make the management of systemic non-Hodgkin lymphoma very difficult. Intensive chemotherapy regimens may be given to low or intermediate risk category patients and conservative chemotherapy regimens to high or poor risk patients (Spina M et al., *Ann Oncol*, 10: 1271-1286, 1999). The prognosis of AIDS-non-Hodgkin lymphoma is very poor.

*Hodgkin disease* in patients with AIDS carries a relative risk much lower than that for non-Hodgkin lymphoma but the histological subtypes tend to be those with unfavourable prognosis and the response rate remains poorer than that of the general population. Outcome may be improved by an optimal combination of anti-neoplastic and HAART to improve control of the underlying HIV infection. The inclusion of growth factors may allow the use of higher doses of the drugs (Vaccher E et al., *Eur J Cancer*, 37: 1306-15, 2001)

*Cervical intraepithelial neoplasia (CIN)* has been increasingly diagnosed in HIV-infected women; *invasive cervical cancer* is currently an AIDS-defining condition. CIN in HIV-infected women is associated with high grade histology, more extensive and/or multifocal disease and disseminated lower genital tract HPV-related lesions (Mandelblatt JS et al., *AIDS*, 6: 173-178, 1992; Robinson W 3<sup>rd</sup>, *Semin Oncol*, 27: 463-470, 2000). Therapeutic recommendations are the same as for non-HIV-infected women, because most HIV-infected women will die from cervical cancer rather than other AIDS-related diseases.

*Testicular cancer* appears to be more frequent in HIV-seropositive homosexual men but the risk is not directly related to the

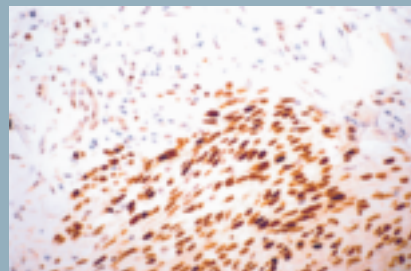

Fig. 2.51 Kaposi sarcoma of the skin in a patient with AIDS. The biopsy (below) reveals the presence of human herpes virus 8 (HHV-8) in tumour cell nuclei, demonstrated by immunohistochemistry (brown colour). Affected individuals are uniformly co-infected with HIV and HHV-8.

level of immune deficiency. Patients with HIV infection are offered the standard chemotherapy, since the majority can be cured of their tumour and have a good quality of life (Bernardi D et al., *J Clin Oncol*, 13, 2705-2711, 1995).

The spectrum of cancers in patients with HIV infection may further increase as these patients survive longer. Based on advances in current understanding of HIV viral dynamics and the availability of newer anti-retroviral therapies, continuation of HAART with prophylaxis against opportunistic infections in patients receiving chemotherapy may significantly improve treatment outcome.

alter gastric acid secretion, elevating gastric pH, changing the gastric flora and allowing anaerobic bacteria to colonize the stomach. These bacteria produce

active reductase enzymes that transform food nitrate into nitrite, an active molecule capable of reacting with amines, amides and ureas to produce carcinogenic

*N*-nitroso compounds. *H. pylori* acts as a gastric pathogen and thereby mediates a carcinogenic outcome involving soluble bacterial products and the inflammatory



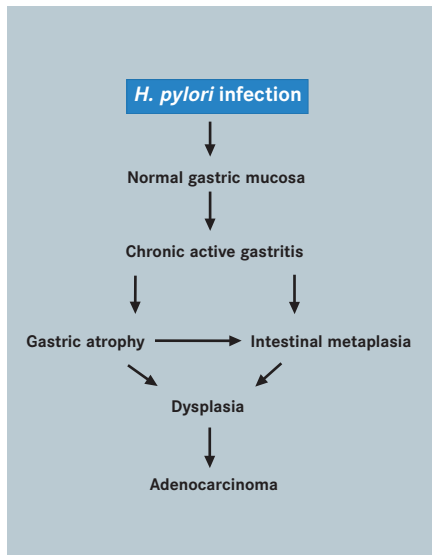

Fig. 2.50 The proposed natural history of the development of stomach cancer as a progressive process associated with atrophy and intestinal metaplasia with reduced acidity.

response generated by the infection (Fig. 2.50).

Infection by the liver fluke *O. viverrini* causes oedema, desquamation and acute inflammatory responses in the bile ducts in the early stages. Bile ducts of chronic carriers may exhibit metaplasia and adenomatous hyperplasia, which progress in some cases to cholangiocarcinoma [4]. Alternatively, such indirect agents may cause immunosuppression and the reactivation of latent oncogenic viruses. In fact, several virus-induced cancers occur almost exclusively under severe immunosuppression (*Immunosuppression*, p68) [6].

### Global burden of cancer attributed to infectious agents

Recent estimates are that at least 1.6 million cases (18%) of the approximately 9 million new cases of cancer that occurred in the world in 1995 can be attributed to the infectious agents discussed (Table

2.18) [2]. The proportion of cancers attributed to infectious agents is higher in developing countries (23%) than in developed countries (9%). This proportion is greatest among women in Western, Eastern and Central Africa, where 40% of all cancers are associated with chronic infections, followed by South-American and Asian women in whom this proportion is around 25% (Fig. 2.47). A similar picture is seen among males but with lower attributable proportions (Fig. 2.48).

The realization that approximately one-quarter of all cancers occurring in the developing world can be attributed to infectious agents opens great hopes for prevention and treatment. This is particularly true for cancers of the cervix, stomach and liver (*Chapter 4*), which are very common in developing countries, where they represent 91% of the cancers associated with infectious agents.

## REFERENCES

1. Rous P (1911) Transmission of malignant new growth by means of a cell-free filtrate. *J Am Med Assoc*, 56: 198.
2. Pisani P, Parkin DM, Muñoz N, Ferlay J (1997) Cancer and infection: estimates of the attributable fraction in 1990. *Cancer Epidemiol Biomarkers Prev*, 6: 387-400.
3. IARC (1994) *Hepatitis Viruses (IARC Monographs on the Evaluation of Carcinogenic Risks to Humans, Vol. 59)*, Lyon, IARC Press.
4. IARC (1994) *Schistosomes, Liver Flukes and Helicobacter Pylori (IARC Monographs on the Evaluation of Carcinogenic Risks to Humans, Vol. 61)*, Lyon, IARC
5. IARC (1995) *Human Papillomaviruses (IARC Monographs on the Evaluation of Carcinogenic Risks to Humans, Vol. 64)*, Lyon, IARC Press.
6. IARC (1996) *Human Immunodeficiency Viruses and Human T-Cell Lymphotropic Viruses (IARC Monographs on the Evaluation of Carcinogenic Risks to Humans, Vol. 67)*, Lyon, IARC Press.
7. IARC (1997) *Epstein-Barr Virus and Kaposi's Sarcoma Herpesvirus/Human Herpesvirus 8 (IARC Monographs on the Evaluation of Carcinogenic Risks to Humans, Vol. 70)*, Lyon, IARC Press.
8. Muñoz N, Bosch FX, de Sanjose S, Tafur L, Izarzugaza I, Gili M, Viladiu P, Navarro C, Martos C, Ascunce N (1992) The causal link between human papillomavirus and invasive cervical cancer: a population-based case-control study in Colombia and Spain. *Int J Cancer*, 52: 743-749.
9. Rolon PA, Smith JS, Muñoz N, Klug SJ, Herrero R, Bosch X, Llamas F, Meijer CJ, Walboomers JM (2000) Human papillomavirus infection and invasive cervical cancer in Paraguay. *Int J Cancer*, 85: 486-491.
10. Walboomers JM, Jacobs MV, Manos MM, Bosch FX, Kummer JA, Shah KV, Snijders PJ, Peto J, Meijer CJ, Muñoz N (1999) Human papillomavirus is a necessary cause of invasive cervical cancer worldwide. *J Pathol*, 189: 12-19.
11. Piot P, Bartos M, Ghys PD, Walker N, Schwartzlander B (2001) The global impact of HIV/AIDS. *Nature*, 410: 968-973.
12. Chey WD (1999) *Helicobacter pylori*. *Curr Treat Options Gastroenterol*, 2: 171-182.
13. zur Hausen H (1999) Viruses in human cancers. *Eur J Cancer*, 35: 1174-1181.

## WEBSITES

- National Center for Infectious Diseases (USA CDC): <http://www.cdc.gov/ncidod/index.htm>
- WHO infectious disease information resources: [http://www.who.int/health\\_topics/infectious\\_diseases/en](http://www.who.int/health_topics/infectious_diseases/en)

# DIET AND NUTRITION

## SUMMARY

- > Up to 30% of human cancers are probably related to diet and nutrition.
- > Excess salt intake causes arterial hypertension and an elevated risk of stomach cancer. Due to modern methods of food preservation, the incidence of stomach cancer is declining worldwide.
- > A Western diet (highly caloric food rich in animal fat and protein), often combined with a sedentary lifestyle and hence energy imbalance, increases the risk of colon, breast, prostate, endometrial and other cancers.
- > Physical activity, avoidance of obesity, and frequent daily intake of fresh fruit and vegetables reduce the risk of oral cavity, lung, cervix uteri and other cancers.

The incidence of most cancers varies worldwide and cancers of the breast, colorectum, prostate, endometrium, ovary and lung are generally much more frequent in the developed countries. These cancers are a major burden in countries of Europe, North America and in Australia. They are markedly less frequent in developing countries of Asia and Africa. In contrast, some cancers of the digestive system, including those of the stomach and liver, are more frequent in developing countries of Central and South America, Africa and Asia than they are in the developed world.

These observations, which were made more than 30 years ago with the publication of the first reliable data on cancer incidence from population-based cancer registries [1,2] are still substantially valid. They constitute one of the basic arguments for the hypothesis that environmental factors play an important role in cancer etiology. A principal environmental factor, now generally recognized as major

determinant of cancer incidence, is diet. Over the past 20 years, many epidemiological studies, particularly case-control studies and, more recently, large cohort studies, have investigated the role of habitual diet in relation to the risk of developing different types of cancer.

## Vegetables and fruit

The most consistent finding on diet as a determinant of cancer risk is the association between consumption of vegetables and fruit and reduced risk of several cancers. Consumption of vegetables and fruit is associated with reduced risk of cancers of the pharynx, larynx, lung, oesophagus, stomach and cervix uteri, while only vegetables, but not fruit, seem to protect against cancers of the colon and rectum. During the last 30 years, over 250 epidemiological studies (case-control, cohort or ecological correlations) have been conducted around the world to investigate the relationship between fruit and vegetable consumption and cancer risk. About 80% of these

studies found a significant protective effect of overall consumption of vegetables and/or fruit, or at least of some types of vegetables and fruits [3]. Preliminary results from the large European Prospective Investigation into Cancer and Nutrition (EPIC) study confirm these results, suggesting, for example, that a daily consumption of 500 g of fruit and vegetables can decrease incidence of cancers of the digestive tract by as much as 25% [4].

Fruit and vegetables do not represent a major source of protein, fat, carbohydrates and therefore energy, but they can be major contributors of fibre, several vitamins, minerals and other biologically active compounds. Current hypotheses on mechanisms through which fruit and vegetables may protect against cancer invoke the interaction of micro-constituents with the processes of carcinogen metabolism, protection of DNA integrity and intercellular communication. Such mechanisms have been studied extensively in experimental systems.



Fig. 2.52 Dietary questionnaires used to assess the quantity of different food types consumed by the participant in a nutritional study.

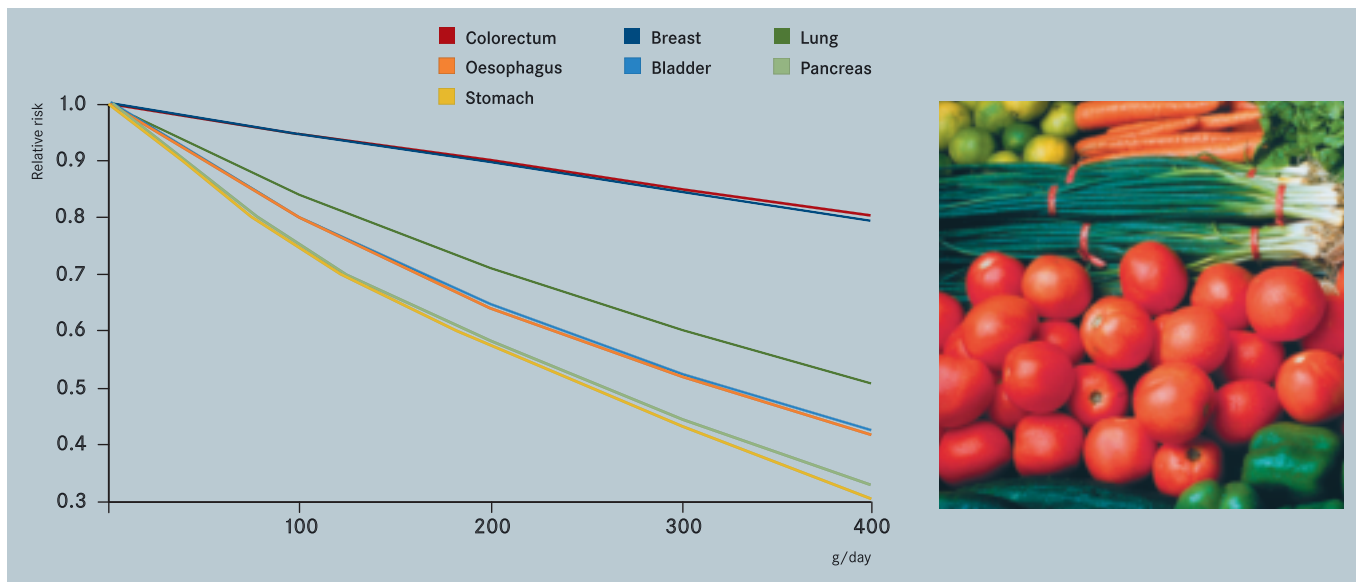

Fig. 2.53 Fruit consumption is associated with reduced risk of cancer (according to results of meta-analyses). Findings are essentially similar for vegetable consumption.



### Salt and salt-preserved foods

Consumption of salt added to food and salt-preserved foods has been investigated mainly in relation to cancers of the stomach, colorectum and nasopharynx. Several studies conducted in Europe, South America and Eastern Asia have reported increased relative risks of stomach cancer in relation to the consumption of salt and salt-preserved foods, particularly in populations with high stomach cancer incidence and high salt intake (Fig. 2.54). Salted, smoked, pickled and preserved food (rich in salt, nitrite and preformed *N*-nitroso compounds) are associated with increased risk of gastric cancer. Such high salt intake, together with *Helicobacter pylori* infection, may contribute to the development of atrophic gastritis, and hence gastric cancer. Domestic refrigeration and reduced salt consumption are likely to have contributed to the observed decreased stomach cancer incidence in developed countries during the 20th century [5].

Consumption of Chinese-style salted fish has been specifically associated with increased risk of nasopharyngeal cancer in South-East Asia [6], whereas European-

style salted fish (e.g. anchovies and salmon) has not been found to be associated with any increase in cancer risk. Several biological mechanisms have been proposed to explain the association between Chinese-style salted fish and nasopharyngeal cancer, including partial fermentation and nitrosamine formation. The relationship of salt and salt-preserved foods with colorectal cancer seems to be of a different nature. Firstly, it has been observed particularly in Western populations and secondly, it mainly involves foods such as cooked and raw ham, various types of salami, European-style *charcuterie*, bacon and other salt-preserved pork (see next section).

### Meat

Epidemiological studies on meat consumption and cancer risk support the existence of a specific association with colorectal cancer risk (Figs. 2.57, 2.58). This association, however, seems to have been found more consistently for consumption of red meat (beef, lamb and pork) and processed meat (ham, salami, bacon and other *charcuterie*) for which consumption of 80 g per day may increase

colorectal cancer risk by 25 and 67%, respectively [7].

Several biological mechanisms have been investigated which could explain the possible effect of meat consumption on colorectal carcinogenesis. These include the influence of meat and/or fat consumption on the production and metabolism of bile salts and bile acids by gut flora [8]. Other hypotheses concern the potential carcinogenic effect of certain compounds that can be formed in meat during cooking, such as heterocyclic amines [9] and polycyclic aromatic hydrocarbons or as a consequence of preserved meat processing (nitrates and nitrites) or endo-intestinal metabolism (various *N*-nitroso compounds) (*Food contaminants*, p43).

### Protein, carbohydrates and fat

The results of epidemiological studies on macro-nutrients (for example, proportion of total diet as protein) have so far been much less consistent in establishing an associated risk of cancer that those on foods. No clear risk patterns have emerged for consumption of protein. Some studies on oesophageal cancer in populations with high alcohol intake found

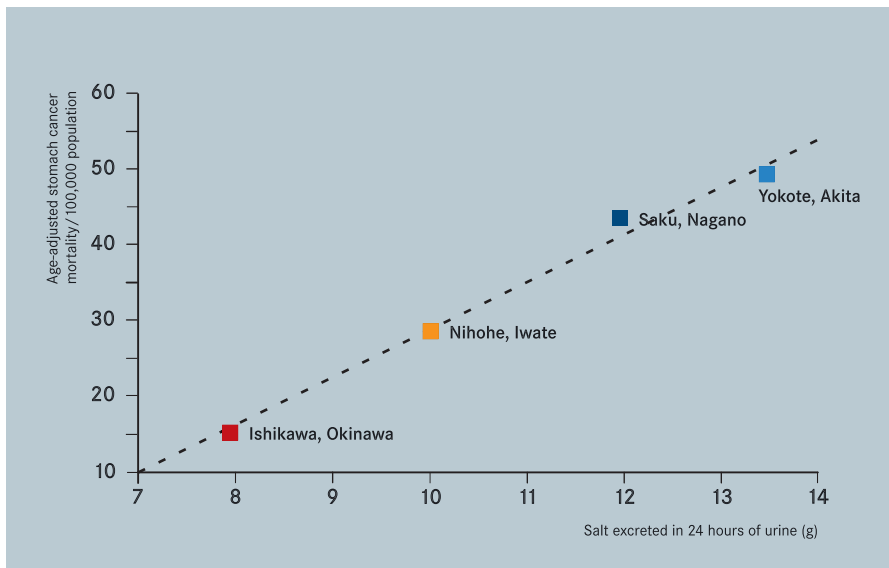

Fig. 2.54 The age-adjusted mortality rate for gastric cancer increases with increasing salt consumption, as measured by 24-hour urine sodium excretion, in selected regions of Japan.

S. Tsugane et al. (1991) *Cancer Causes Control*, 2:165-8.



Fig. 2.55 Consumption of salted fish (such as this salted cod) is associated with an increased risk of stomach cancer.

a protective effect of animal protein (and meat) while some studies on colorectal cancer found an increased risk for animal protein (and meat).

Results on carbohydrates are difficult to interpret because of inconsistencies in the way different food composition tables subdivide total carbohydrates into sub-fractions that have very different physiological and metabolic effects and which may affect carcinogenesis in opposite ways. The only pattern that seems to emerge so far is that consumption of simple sugars (mono- and disaccharides) may be associated with increased colorectal cancer risk, while consumption of complex polysaccharides, non-starch polysaccharides and/or fibre (partially overlapping categories based on different chemical and physiological definitions) is associated with lower cancer risk. Other less consistent findings suggest that a diet excessively rich in starchy foods (mainly beans, flour products or simple sugars) but also poor in fruit and vegetables, may be associated with increased gastric cancer risk.

The hypothesis that high fat intake is a major cancer risk factor of the Western-style diet has been at the centre of most

epidemiological and laboratory experimental studies. The results are, however, far from clear and definitive. The positive association with breast cancer risk suggested by international correlation studies and supported by most case-control studies was not found in the majority of the prospective cohort studies conducted so far. Very few studies have investigated the effect of the balance between different types of fats, specifically as containing poly-unsaturated, mono-unsaturated and saturated fatty acids, on cancer risk in humans. The only moderately consistent result seems to be the positive association between consumption of fats of animal origin (except for fish) and risk of colorectal cancer. Additionally, olive oil in the context of the Mediterranean dietary tradition is associated with a reduced risk of cancer [10].

#### Food additives

Food additives are chemicals added to food for the purpose of preservation or to enhance flavour, texture or colour. Less than comprehensive toxicological data are available for most additives, although some have been tested for mutagenic or carcinogenic activity. In *in vitro* assay sys-

tems, some additives, such as dietary phenolics, have both mutagenic and anti-mutagenic effects [11]. In the past, some chemicals were employed as food additives before their carcinogenicity in animals was discovered, e.g. the colouring agent "butter yellow" (dimethylaminoazobenzene) and, in Japan, the preservative AF2 (2-(2-furyl)-3-(5-nitro-2-furyl) acrylamide). Saccharin and its salts have been used as sweeteners for nearly a century. Although some animal bioassays have revealed an increased incidence of urinary bladder cancer, there is inadequate evidence for carcinogenicity of saccharin in humans [12]. The proportion of



Fig. 2.56 Saccharin with a warning label recognizing a possible role in cancer causation.



dietary-related cancers considered attributable to food additives is very low [13].

### Micronutrients

Research on vitamins and cancer in humans has focused mainly on carotenoids and vitamin A (retinol), vitamin E, vitamin C and some of the group of B vitamins (folic acid, B<sub>9</sub>). The biological basis of the interest in these vitamins is their involvement in either of two metabolic mechanisms commonly called the antioxidant effect (carotenoids, vitamins C and E) and methyl donation (folic acid, B<sub>9</sub>) (*Chemoprevention*, p151).

case-control studies based on dietary questionnaires and several small prospective cohort studies based on blood measurements have shown quite consistently that individuals with lower carotenoid levels have increased lung cancer risk. Less consistent and weaker protective effects of carotenoids have also been reported for cancers of the oesophagus, stomach, colorectum, breast and cervix. Low dietary intake of vitamin C has been found to be associated with increased risk of cancers of the stomach, mouth, pharynx, oesophagus and, less consistently, with cancers of the lung, pancreas and cervix. Although results on vitamin E and cancer are less strong and consistent than those on carotenoids and vitamin C, several

studies have suggested that low vitamin E intake is related to increased risk of cancers of the lung, cervix and colorectum. Studies to investigate the effect of dietary supplementation with vitamins on cancer risk have had varying results (*Chemoprevention*, p151). Two large studies, ATBC and CARET [14], observed increases in lung cancer incidence of 18% and 28% respectively in the group receiving  $\beta$ -carotene ( $\beta$ -carotene plus vitamin A in CARET). In the ATBC study, the group receiving a vitamin E supplement had a 34% reduction in prostate cancer incidence, but deaths from cerebrovascular accidents doubled and there was no decrease in total mortality.

There is rising interest in the possible cancer-preventive effect of folic acid; some prospective studies have shown that high dietary intakes and higher blood levels may be associated with reduced risk of cancers and adenomatous polyps of the colorectum. Folates and vitamin B<sub>9</sub> are involved in the synthesis of methionine and choline as methyl donors. Folate deficiency leads to an accumulation of homocysteine. High homocysteine levels have recently been found to be strongly associated with death from myocardial infarction, total mortality and colon cancer risk [15]. Epidemiological studies conducted in populations with a high incidence of

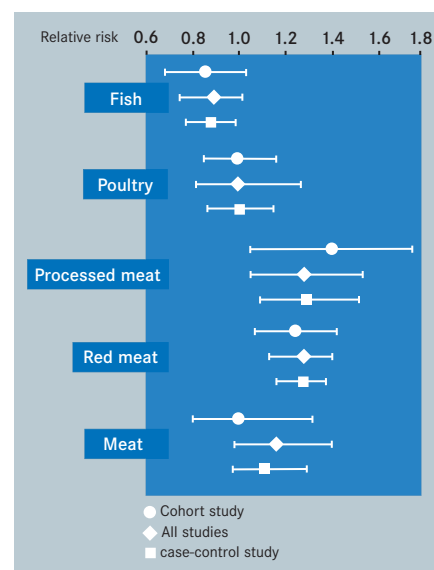

Fig. 2.57 Influence of the consumption of fish and different types of meat on the relative risk of developing colorectal cancer [7].

oesophageal cancer in China found that zinc deficiency was common in these populations. Some experimental studies also suggest that selenium deficiency may increase cancer risk [16]. Several epidemiological studies have examined the association between cancer risk and deficiencies of one of these minerals, with very variable results.

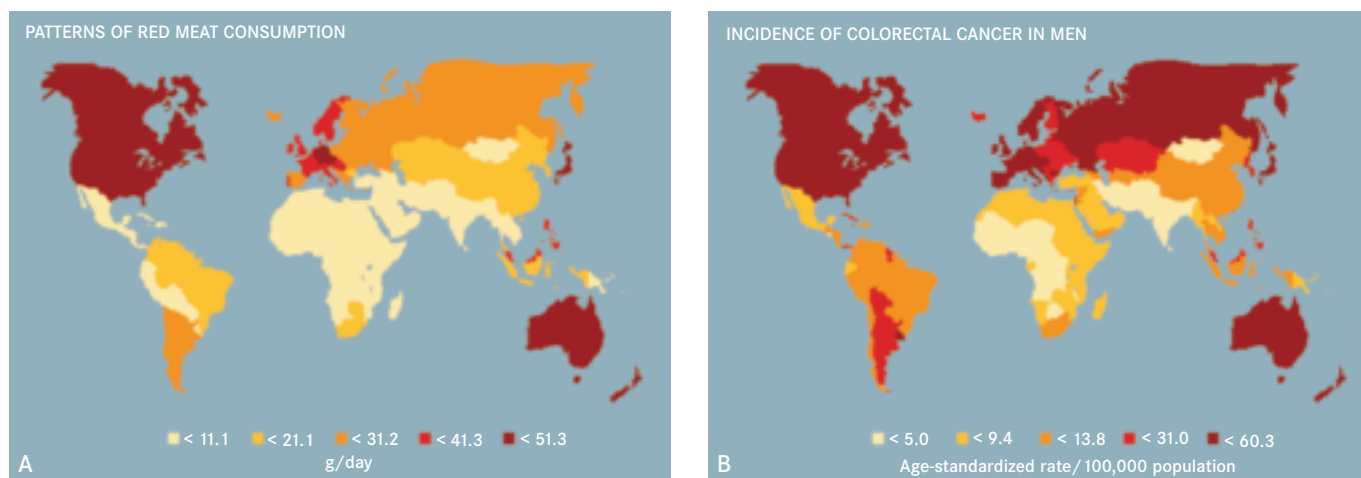

Fig. 2.58 The global levels of (A) red meat consumption (beef, lamb and pork) and its relationship to (B) the incidence of colorectal cancer. The biological basis of the correlation between these two variables is complex and not yet fully understood.



## OVERWEIGHT, OBESITY AND PHYSICAL ACTIVITY

The body mass is most usefully measured as the body mass index (BMI), calculated by dividing the body weight in kilograms by the height in metres squared. The normal range is 18.5 to 25; overweight corresponds to BMI > 25 and obesity to a value greater than 30. In many developed countries, as much as half of the adult population may be overweight and more than 25% obese. Epidemiological studies have shown with varying degrees of consistency that excess body mass is associated with an increased cancer risk.

The strongest and most consistent association with body mass has so far been seen for endometrial cancer, the risk of which is increased two- to six-fold in obese compared to lean women, both before and after menopause. A possible biological explanation for this association is that adipose tissue is rich in aromatase, which converts androstenedione to estrone, thus increasing estrogenic stimulation of the endometrial mucosa. Several studies have investigated markers of fat distribution such as waist-to-hip ratio or subscapular-to-tight-skinfold ratio

in relation to endometrial cancer risk, with inconsistent results. Some studies found increased risk for markers of abdominal or android obesity (high waist-to-hip ratio or subscapular-to-tight-skinfold ratio) after adjustment for body mass index, while others did not.

The relationship between body mass index and breast cancer is even more complex. The majority of case-control and prospective studies found that high body mass index increased breast cancer risk in postmenopausal women, while it may slightly reduce risk in premenopausal women. A possible explanation for this apparent paradox is that overweight before menopause could be related to anovulatory cycles and fewer ovulatory cycles (as determined by pregnancy and lactation) are generally associated with lower breast cancer risk. After menopause, obesity may act as for endometrial cancer by enhancing the peripheral (as opposed to gonadal and adrenal) production of estrogens.

There is growing evidence that metabolic factors related to diet, nutritional status, anthropometry and physical activity have an influence on the development and clinical manifestation of various forms of can-

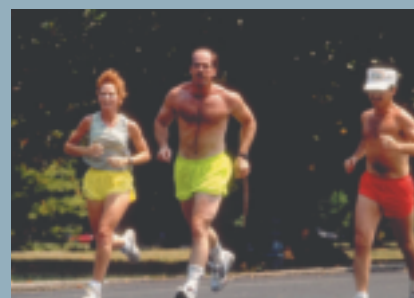

Fig. 2.59 Regular physical exercise appears to be correlated with decreased risk of cancer.

cer (*Weight Control and Physical Activity, IARC Handbooks of Cancer Prevention, Vol. 6, 2001*). Epidemiological studies suggest certain different dietary patterns may be specifically related to higher risk of particular types of cancer. The Western diet and lifestyle are generally associated with high incidence of cancers of the colorectum, breast, prostate and endometrium, but with low incidence of cancers of the stomach, oesophagus, liver and cervix uteri (see *Reproductive factors and hormones, p76*).

### Caloric intake and other dietary-related factors

The results of animal experiments in which dietary restriction decreases the risk of cancer at some sites are not readily extrapolated to humans. While caloric intake can be employed as a single parameter of diet, caloric intake considered in isolation is an inadequate basis upon which to address a broad spectrum of studies concerning cancer risk. These studies indicate inter-relationships between caloric intake, body mass and physical activity. Thus it is argued that high energy intake *per se* is not a risk factor for cancer, but positive energy balance (energy balance being the difference

between caloric intake and caloric expenditure) leading to obesity is a cancer risk factor [17]. Data have accumulated suggesting that some metabolic factors related to nutritional status, such as obesity and physical activity, may also play a role by increasing the risk of certain cancers (Box: *Overweight, obesity and physical activity, above*).

Recently, several prospective studies have lent strong support to the hypothesis formulated decades ago regarding the prominent role of endogenous hormone levels in determining risk of cancer of the breast. It is also proposed that the insulin-resistance syndrome may underlie the relationship between obesity and hormone-

dependent cancers. Variations in the pattern of estrogens, androgens, insulin-like growth factor and their binding proteins are probably determined by both environmental and lifestyle factors, as well as by inherited genetic characteristics, as suggested by recent studies on polymorphisms of genes encoding for enzymes regulating steroid hormone metabolism and hormone receptors (*Reproductive factors and hormones, p76*)

Accordingly, the relationship between diet and cancer is proving to be more complex than was previously thought. Research based on a combination of laboratory investigations on human subjects and sound epidemiological projects of a

prospective nature is likely to shed new light on the link between nutritionally related factors and cancer [18]. In the

meantime, public health recommendations should focus on the benefits that can be expected from a diet rich in veg-

etables and fruit, the maintenance of a healthy weight and a physically active lifestyle.

## REFERENCES

1. Doll R, Payne P, Waterhouse J, eds (1966) *Cancer Incidence in Five Continents - A Technical Report*, Berlin, Springer-Verlag.
2. Doll R, Muir C, Waterhouse J, eds (1970) *Cancer Incidence in Five Continents*, Berlin, Springer-Verlag.
3. WCRF/AICR (1997) *Food, Nutrition and the Prevention of Cancer: a Global Perspective*, World Cancer Research Fund/American Institute of Cancer Research.
4. Bueno-de-Mesquita HB, Ferrari P, Riboli E on behalf of EPIC (2002) Plant foods and the risk of colorectal cancer in Europe: preliminary findings. In Riboli E, Lambert R, Eds. *Nutrition and Lifestyle: Opportunities for Cancer Prevention (IARC Scientific Publication No. 156)*, Lyon, IARC Press.
5. Palli D (2000) Epidemiology of gastric cancer: an evaluation of available evidence. *J Gastroenterol*, 35 Suppl 12: 84-89.
6. IARC (1993) *Some Naturally Occurring Substances: Food Items and Constituents, Heterocyclic Aromatic Amines and Mycotoxins (IARC Monographs on the Evaluation of Carcinogenic Risks to Humans, Vol. 56)*, Lyon, IARC Press.
7. Norat T, Lukanova A, Ferrari P, Riboli E (2002) Meat consumption and colorectal cancer risk: dose response meta-analysis of epidemiological studies. *Int J Cancer*, 98: 241-256.
8. Reddy B, Engle A, Katsifis S, Simi B, Bartram HP, Perrino P, Mahan C (1989) Biochemical epidemiology of colon cancer: effect of types of dietary fiber on fecal mutagens, acid, and neutral sterols in healthy subjects. *Cancer Res*, 49: 4629-4635.
9. Layton DW, Bogen KT, Knize MG, Hatch FT, Johnson VM, Felton JS (1995) Cancer risk of heterocyclic amines in

cooked foods: an analysis and implications for research. *Carcinogenesis*, 16: 39-52.

10. Trichopoulou A, Lagiou P, Kuper H, Trichopoulos D (2000) Cancer and Mediterranean dietary traditions. *Cancer Epidemiol Biomarkers Prev*, 9: 869-873.
11. Ferguson LR (1999) Natural and man-made mutagens and carcinogens in the human diet. *Mutat Res*, 443: 1-10.
12. IARC (1999) *Some Chemicals that Cause Tumours of the Kidney or Urinary Bladder in Rodents and Some Other Substances (IARC Monographs on the Evaluation of Carcinogenic Risks to Humans, Vol. 73)*, Lyon, IARC Press.
13. Doll R, Peto R (1981) The causes of cancer: quantitative estimates of avoidable risks of cancer in the United States today. *J Natl Cancer Inst*, 66: 1191-1308.
14. Goodman GE (2000) Prevention of lung cancer. *Crit Rev Oncol Hematol*, 33: 187-197.
15. Choi SW, Mason JB (2000) Folate and carcinogenesis: an integrated scheme. *J Nutr*, 130: 129-132.
16. Clark LC, Dalkin B, Krongrad A, Combs GF, Jr., Turnbull BW, Slate EH, Witherington R, Herlong JH, Janosko E, Carpenter D, Borosso C, Falk S, Rounder J (1998) Decreased incidence of prostate cancer with selenium supplementation: results of a double-blind cancer prevention trial. *Br J Urol*, 81: 730-734.
17. Willett WC (2001) Diet and cancer: one view at the start of the millennium. *Cancer Epidemiol Biomarkers Prev*, 10: 3-8.
18. Riboli E, Kaaks R (2000) Invited commentary: the challenge of multi-center cohort studies in the search for diet and cancer links. *Am J Epidemiol*, 151: 371-374.

## WEBSITE

NCI Division of Cancer Prevention: Diet, food, nutrition: <http://www.cancer.gov/prevention/lifestyle.html#diet>

# IMMUNOSUPPRESSION

## SUMMARY

- > Persistent suppression of the immune system results in an increased cancer risk.
- > An increased incidence of malignant lymphomas, of which the majority contain the Epstein-Barr virus, is caused by immunosuppressive drugs used to prevent the rejection of organ transplants.
- > Infectious agents that cause severe immune suppression, such as the human immunodeficiency virus (HIV), are associated with an increased incidence of several tumours, including non-Hodgkin lymphoma and Kaposi sarcoma.

Immunosuppression is a reduction in the capacity of the immune system to respond effectively to foreign antigens, and can be either transient or permanent.

Certain chemicals and drugs, ionizing radiation, and infection with particular viruses and parasites can cause immunosuppression. This phenomenon is observed in humans and in experimental animals. Immunosuppression after exposure to X-rays or other ionizing radiation is most pronounced when the entire body, rather than a limited area, is irradiated. Immunosuppression by chemicals or radiation is dose-dependent, the intensity and duration of the effect increasing with increasing dose or continuing exposure, and is generally reversible with cessation of exposure. In contrast, infection with certain pathogens, such as human immunodeficiency virus, is persistent and the immune deficiency that results is progressive, unless the infection is effectively treated.

Immunosuppression should be distinguished from various forms of immune deficiency resulting from certain genetic defects (e.g. ataxia telangiectasia, *ATM*; Wiskott-Aldrich Syndrome, *WASP*; X-linked

severe combined immunodeficiency,  $\gamma\text{c}$ ). Persistent immunosuppression, especially when accompanied by continuing exposure to foreign antigens such as organ transplants, presents a risk for cancer, though not all tumour types arise with equal frequency. Ciclosporin and related compounds are widely used to facilitate organ transplantation by decreasing the risk of rejection. Risk is especially high for various forms of lymphoma and for certain other cancers that are associated with viral infections.

### Immunosuppression mediated by drugs

Immunosuppression achieved by administration of drugs is used to treat autoimmune diseases (e.g. rheumatoid arthritis) and, usually involving the relevant drugs at much higher dosage, to maintain the functional and anatomic integrity of foreign tissues grafted to another individual. A graft from any individual except oneself or an identical twin will provoke an immune reaction against the grafted tissues, the intensity of which varies with the degree of antigenic difference between graft and host. In

the absence of adequate immunosuppression, the host will destroy the graft. Whole organs (e.g. kidney, heart, liver, lung) can be transplanted with maintenance of function that may continue for a lifetime when appropriate levels of immunosuppression are maintained. The risk of cancer increases with increasing intensity and duration of immunosuppression [1].

Apart from deliberate suppression of the immune response in the context of organ transplantation, immunosuppression may arise as a side-effect of some drugs, and specifically many cytotoxic agents widely used in cancer chemotherapy. This action may contribute to the development of "second cancers", particularly in children. More generally, patients receiving cancer chemotherapy are vulnerable to infectious disease as a result of their immune system being compromised.

The suggested mechanisms of action of immunosuppressive agents [2] include:

- Interference with antigen-presentation mechanisms;
- Interference with T-cell function; inhibition of signal transduction or receptor actions (ciclosporin);

Drug or infectious agent	Cancer site/cancer
Azathioprine	Non-Hodgkin lymphoma, Kaposi sarcoma, squamous cell carcinoma of the skin, hepatobiliary cancers, mesenchymal tumours.
Cyclophosphamide	Bladder cancer
Ciclosporin	Non-Hodgkin lymphoma, Kaposi sarcoma
Human immunodeficiency virus-1 (HIV-1)	Non-Hodgkin (B-cell) lymphoma, Kaposi sarcoma (increased risk by coinfection with herpesvirus 8)
Epstein-Barr virus	Burkitt lymphoma (in conjunction with malaria infection), non-Hodgkin (B-cell) lymphoma in immunosuppressed patients, Hodgkin disease, smooth muscle tumours in immunosuppressed individuals
Human herpesvirus 8	Kaposi sarcoma
Human papillomaviruses	Cancers of cervix, vulva and anus

Table 2.19 Immunosuppressive agents associated with development of cancer.

- Interference with B-cell function;
- Interference with proliferation; clonal expansion (cyclophosphamide, methotrexate).

Organ transplant recipients receiving immunosuppressive drugs are at increased risk of non-Hodgkin lymphoma and some other cancers, especially non-melanoma skin cancer and Kaposi sarcoma (Table 2.19). Some such tumour types exemplify the manner in which immunosuppression has been otherwise linked to malignancy. Thus, a factor in the development of skin cancer is the ability of ultraviolet B radiation to suppress the immune response. Such immunomodulation may be by multiple mechanisms but generally manifests in an antigen-presenting cell defect and an altered cytokine environment in the draining lymph nodes [3]. Consistent with a role of immunosuppression in the etiology of these tumours, immunosuppression profoundly influences the prevalence of skin disorders in transplant patients: skin tumours occur with high incidence in such patients and constitute a major part of transplantation-related morbidity and mortality. On the other hand, evidence of immune system abnormalities is lacking in most patients with mature B-cell neoplasms. Nonetheless, immunosuppressed patients have a markedly increased incidence of such non-Hodgkin lymphoma [4].

More than 95% of all human beings are infected with the oncogenic herpesvirus, Epstein-Barr virus (EBV), which rarely causes clinically apparent disease except in immunocompromised individuals, including organ transplant recipients. Epstein-Barr virus-associated lymphoproliferative diseases in immunocompromised patients include a spectrum of mainly B-cell diseases that range from polyclonal lymphoproliferative diseases, which resolve when immunosuppression is halted, to highly malignant lymphomas [5]. EBV transforms lymphoid cells and the neoplastic cells can survive and proliferate to produce lymphomas very rapidly in an immunocompromised individual [6]. Because of the synergistic effects of EBV and immunosuppressive drugs in the cau-

sation of these lymphomas, both EBV and some of the drugs listed in Table 2.19 are classified in Group 1 (carcinogenic to humans) by the *IARC Monographs on the Evaluation of Carcinogenic Risks to Humans*. Cancers of the anogenital region are caused by infections with human papillomaviruses, and the incidence of such cancers is greatly increased in organ transplant recipients.

Autoimmune conditions for which immunosuppressive therapy is indicated include rheumatoid arthritis and lupus erythematosus and others. Milder therapy and, often, less potent immunosuppressive drugs (e.g. steroids such as prednisone) are generally used than for organ transplant recipients. Generally there are elevated risks for the same cancers as occur in excess in organ transplant recipients, but these risks are much lower in patients without an organ transplant. Prednisone and related immunosuppressive steroid drugs have not been shown to be carcinogenic.

Immunosuppression that will allow transplanted normal tissues to survive in a foreign host can also allow occult tumours within the transplanted tissues to survive and grow in the transplant recipient. Such transplanted cancers regress when immunosuppressive therapy is withdrawn [7].

### Immunosuppression by carcinogens

As implied by the number of malignancies which emerge once the immune system is compromised, growth of tumours generally may be perceived as requiring a degree of failure by the immune response. Generally, chemical carcinogens are not characterized as immunotoxic. However, particular substances may exert some degree of immunosuppressive activity that may thus affect tumour growth in a manner comparable to that exerted by ultraviolet light in the etiology of skin cancer [2]. Thus TCDD (2,3,7,8-tetrachlorodibenzo-*para*-dioxin) is immunotoxic in primates, suggesting that humans exposed to this pollutant may be similarly affected, although no direct evidence was found to support this in a study of exposed residents living in a contaminated area in Seveso, Italy.



Fig. 2.60 Transport of an organ for transplantation. Immunosuppressed transplant patients exhibit an increased incidence of tumours, particularly lymphomas.

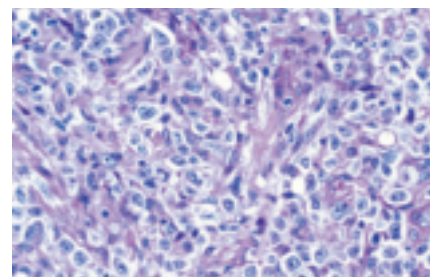

Fig. 2.61 An Epstein-Barr virus-positive, diffuse large B-cell lymphoma of soft tissue, arising in a patient with rheumatoid arthritis treated with methotrexate.

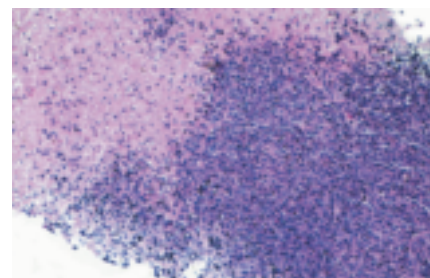

Fig. 2.62 A liver biopsy showing partial replacement of hepatocytes by diffuse large B-cell lymphoma of the immunoblastic variant, a lymphoproliferative disease which arose after organ transplant.

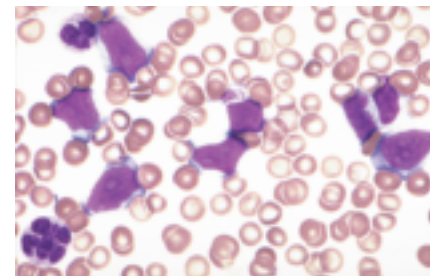
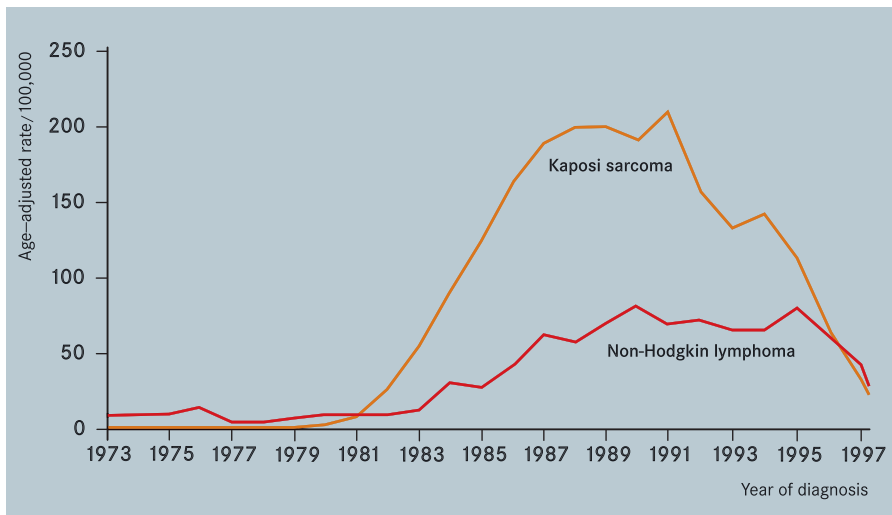

Fig. 2.63 Bone marrow smear of an acute myeloid leukaemia arising in a cancer patient treated with alkylating agents. Note the increased numbers of basophils.



**Fig. 2.64** Cancer following immunosuppression as a result of infection. The annual incidence of Kaposi sarcoma and non-Hodgkin lymphoma in San Francisco, USA, 1973–1998. Incidence increased dramatically between 1982 and 1990 as a result of the AIDS/HIV epidemic. Recent declines are partly attributable to the introduction of HAART therapy, although long-term risks remain unclear (Box: *Tumours associated with AIDS/HIV*, p60). C. Clarke (2001) *AIDS*, 15: 1913–1914

## Immunosuppression caused by infectious agents

Immunosuppression as a consequence of infection is especially severe in individuals infected with human immunodeficiency virus (HIV), the cause of acquired immune deficiency syndrome (AIDS). Certain cancers are characteristic of AIDS and in fact are AIDS-defining conditions in HIV-infected individuals [8]. These include non-Hodgkin lymphoma, especially of the brain, associated with EBV co-infection, and Kaposi sarcoma, which is associated with co-infection with another oncogenic herpesvirus, human herpesvirus 8 (Box: *Tumours associated with HIV/AIDS*, p60). The incidence of such tumours is increasing, partly as a result of the AIDS epidemic (Fig. 2.64). Both EBV and HIV-1, the principal cause of AIDS, are classified as Group 1 – carcinogenic to humans – in the *IARC Monographs*.

## REFERENCES

1. Kinlen LJ (1996) Immunologic factors, including AIDS. In: Schottenfeld D, Fraumeni, JF eds, *Cancer Epidemiology and Prevention*, New York, Oxford University Press, 532–545.
2. Neubert R, Neubert D (1999) Immune system. In: Marquardt H, Schafer SG, McClellan RO, Welsch F eds, *Toxicology*, San Diego, Academic Press, 371–436.
3. Hart PH, Grimbaldston MA, Finlay-Jones JJ (2001) Sunlight, immunosuppression and skin cancer: role of histamine and mast cells. *Clin Exp Pharmacol Physiol*, 28: 1–8.
4. Penn I (2000) Cancers in renal transplant recipients. *Adv Ren Replace Ther*, 7: 147–156.
5. Mosier DE (1999) Epstein-Barr virus and lymphoproliferative disease. *Curr Opin Hematol*, 6: 25–29.
6. IARC (1997) *Epstein-Barr Virus and Kaposi's Sarcoma Herpesvirus / Human Herpesvirus 8 (IARC Monographs on the Evaluation of Carcinogenic Risks to Humans, Vol. 70)*, Lyon, IARC Press.
7. Wilson RE, Hager EB, Hampers CL, Corson JM, Merrill JP, Murray JE (1968) Immunologic rejection of human cancer transplanted with a renal allograft. *N Engl J Med*, 278: 479–483.
8. IARC (1996) *Human Immunodeficiency Viruses and Human T-Cell Lymphotropic Viruses (IARC Monographs on the Evaluation of Carcinogenic Risks to Humans, Vol. 67)*, Lyon, IARC Press.

## WEBSITES

International Association of Physicians in AIDS Care:  
<http://www.iapac.org/>  
 The Transplantation Society:  
<http://www.transplantation-soc.org/>  
 The United Network for Organ Sharing:  
<http://www.unos.org/>



# GENETIC SUSCEPTIBILITY

## SUMMARY

- > Inherited cancer syndromes, usually involving germline mutations in tumour suppressor or DNA repair genes, may account for up to 4% of all cancers.
- > Inherited mutations of the *BRCA1* gene account for a small proportion of all breast cancers, but affected family members have a greater than 70% lifetime risk of developing breast or ovarian cancer.
- > Identification of a germline mutation allows for preventive measures, clinical management and counselling.
- > Environmental factors may modify the cancer risk of individuals affected by inherited cancer syndromes.
- > Altered cancer susceptibility may be mediated by genetic variations in genes which, while not causing cancer, affect metabolism of carcinogens such as tobacco smoke.

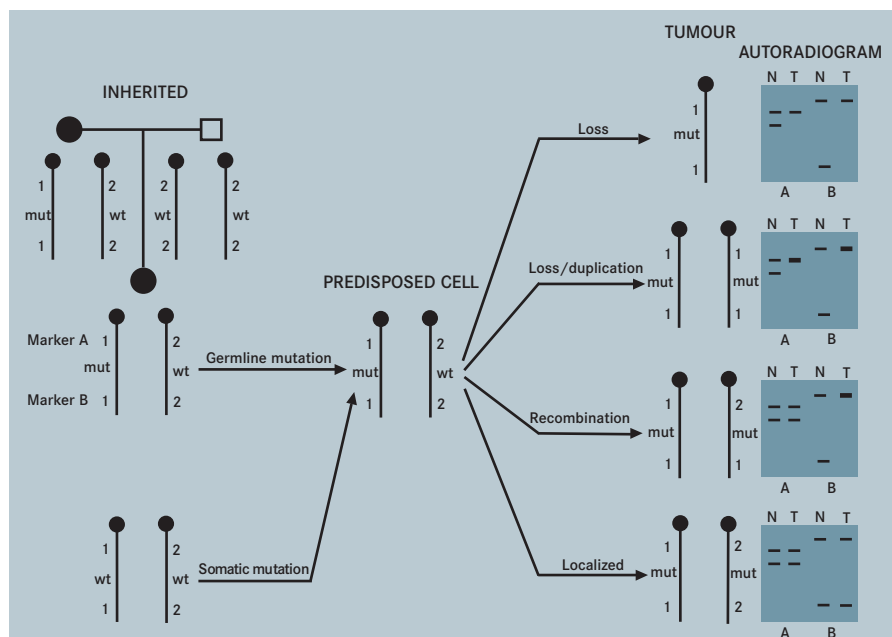

Fig. 2.65 Knudson's hypothesis, explaining the development of an inherited cancer caused by the inactivation of a suppressor gene. Tumours of the eye (retinoblastoma) in individuals who have inherited a mutation in one allele of the retinoblastoma gene on chromosome 13 ("mut") rather than the normal wild-type ("wt"), almost always occur in both eyes, due to inherited susceptibility. When this tumour type occurs spontaneously in a single retinal cell ("sporadic") by a somatic mutation, only one eye is affected. The mechanisms by which the tumour arises can be determined by analysing the genotypes produced from normal ("N") and tumour ("T") tissues.

The genetic basis of cancer may be understood at two levels. Firstly, malignant cells differ from normal cells as a consequence of the altered structure and/or expression of oncogenes and tumour suppressor genes, which are found in all cancers. In this case, "the genetic basis of cancer" refers to acquired genetic differences (somatic) between normal and malignant cells due to mutation in the one individual. Secondly, the same phrase, "the genetic basis of cancer" may be used to refer to an increased risk of cancer that may be inherited from generation to generation. This section is concerned with the latter phenomenon. In many instances, the genes concerned have been identified, and have also sometimes been found to play a role in sporadic cancers as well.

### Interplay between genes and environmental factors

The influence of lifestyle factors (especially smoking), occupational exposures, dietary habits and environmental exposures (such as air pollution, sun exposure or low levels of radiation) on the development of cancer is clear; such factors account for a specific fraction of cancers. Another large fraction of cancers is caused by viral and other infectious agents, this being particularly relevant to the developing world. Carcinogenic agents, as diverse as chemicals, radiation and viruses, act primarily by damaging DNA in individual cells. Such damage has broad ramifications when it involves disruption of genes which control cell proliferation, repair of further DNA damage, and ability of cells to infiltrate (invade) surrounding tissue

(Chapter 3). Because each of these changes is relatively rare, the chance that the necessary combination of such events occurs to allow a normal cell to progress into a fully malignant tumour is small. However, the risk to an individual over his or her lifetime can be as large as 10% for cancers of the breast or prostate (that is, in some instances, 10% of the population will suffer from one of these cancer types in their lifetime). Genetic alterations accumulate gradually either through random events and/or by the action of specific environmental carcinogens, and thus most cancers in the population occur in middle-aged and elderly individuals. Some individual cancers can be attributed to particular environmental factors. In the absence of apparent causative factors, a cancer is described as "sporadic" or "spontaneous".

Syndrome	Gene	Location	Cancer site/cancer
Familial retinoblastoma	<i>RB1</i>	13q14	Retinoblastoma, osteosarcoma
Multiple endocrine neoplasia II	<i>RET</i>	10q11	Medullary thyroid carcinoma, pheochromocytoma
Multiple endocrine neoplasia I	<i>MEN1</i>	11q13	Adrenal, pancreatic islet cells
Neurofibromatosis type I	<i>NF1</i>	17q11	Neurofibromas, optic gliomas, pheochromocytoma
Neurofibromatosis type II	<i>NF2</i>	22q2	Bilateral acoustic neuromas, meningiomas, cerebral astrocytomas
Bloom syndrome	<i>BLM</i>	15q26	Leukaemia, lymphoma
Familial adenomatous polyposis	<i>APC</i>	5q21	Colorectal, thyroid
Von Hippel-Lindau	<i>VHL</i>	3p25	Renal cell carcinoma, pheochromocytoma
Familial Wilms tumour	<i>WT1</i>	11q	Wilms tumour (kidney)
Xeroderma pigmentosum	<i>XP(A-D)</i>	9q, 3p, 19q, 15p	Basal cell carcinoma, squamous cell carcinoma, melanoma (skin)
Fanconi anaemia	<i>FAC</i>	16q, 9q, 3p	Acute leukaemia
Li-Fraumeni syndrome	<i>p53</i>	17p13,	Breast and adrenocortical carcinomas, bone and soft tissue sarcomas, brain tumours, leukaemia
Cowden syndrome	<i>PTEN</i>	10q22	Breast, thyroid
Gorlin syndrome	<i>PTCH</i>	9q31	Basal cell carcinoma
X-linked proliferative disorder	<i>XLP</i>	Xq25	Lymphoma
Peutz-Jeghers syndrome	<i>LKB1</i>	19p	Breast, colon
Ataxia telangiectasia	<i>ATM</i>	11q22	Leukaemia, lymphoma

**Table 2.20** Inherited cancer syndromes caused by a single genetic defect. The lifetime risk of cancer is high. There are usually recognizable phenotypic features that make the syndromes easy to identify clinically.

Although most cancers arise through somatically acquired mutations (which are found uniformly only in relevant tumour cells), about 5% of all cancers can be attributed to inherited gene alterations which are common to every cell in an affected individual. Such a genetic change may be present in, and hence inherited from, one parent or may have occurred in a germ cell (egg or sperm cell) before fertilization, and may, in

turn, be passed on to the next generation. These alterations, in every cell, constitute a partial commitment to cancer which may be completed either by random processes or as a result of environmental insults. This theory of why tumour development preferentially occurs in individuals with a genetic predisposition was first proposed by Alfred Knudson in 1971 in the context of a childhood eye tumour, familial retinoblastoma [1]



**Fig. 2.66** Child with retinoblastoma, a malignant tumour of the eye, which arises from retinal germ cells. In the familial form it is caused by an autosomal dominant mutation of the retinoblastoma gene.



**Fig. 2.67** Patient with xeroderma pigmentosum, a rare inherited (autosomal recessive) disease, exhibiting spots of hyperpigmentation in sun-exposed portions of the skin, which are prone to develop into multiple skin cancers. The disease is caused by mutations in genes involved in DNA repair.

(Figs. 2.65, 2.66). In general, inherited forms of cancer occur at an earlier age than sporadic or environmentally-caused tumours. Thus although only a relatively small fraction of all cancers are attributable to inherited mutations in cancer susceptibility genes, such “germline” alterations account for a significant fraction of cancers occurring at young ages. It is also likely that individual differences in the ability to detoxify or metabolize carcinogens (*Carcinogen activation and DNA repair*, p89) or regulate levels of hormones (*Reproductive factors and hormones*, p76) are under some degree of genetic control. Both of these forms of variation would modify the effects of environmental exposures and the consequent cancer risk.

## Cancer genes

The fact that cancer can “run in families” has been recognized for over a century. Among the earliest recorded evidence for inherited susceptibility is a description by a Parisian physician, Paul Broca, of a family with many cases of early onset breast cancer, liver cancer or other tumours [2]. Such families have proven to be key resources in establishing the inheritance of disease from generation to generation. By analysing DNA extracted from a blood or tumour sample from members of these families, the inheritance of cancer susceptibility within a family can be tracked to determine whether the disease is transmitted from parent to child together with a “genetic marker”, that is, a gene sequence which may not have any clinical significance but which is highly variable between individuals. If this is the case, and if this is also true for a sufficient number of other families, the approximate location of the gene causing the disease can be determined. From there, it is a matter of using more molecular-based strategies to home in on and identify the specific gene involved and localize the predisposing gene to a small region within the overall human genome. This allows the identification of the specific genes involved and of the alterations in those genes predisposing an individual to cancer [3].

Specific genes involved in susceptibility to many forms of cancer, both rare tumours such as retinoblastoma, and more common cancers such as breast and colon, have been identified and are designated as “tumour suppressor genes” or “oncogenes” (*Oncogenes and tumour suppressor genes*, p96). For other forms of inherited cancer, only the chromosomal location of a putative susceptibility gene is known; the specific gene involved has not yet been identified. Many of the early successes involved identifying the genetic defects, and subsequently the genes responsible for specific cancer-associated syndromes such as neurofibromatosis, familial adenomatous polyposis and Li-Fraumeni syndrome. Neurofibromatosis types are respectively associated with *NF1* and *NF2* genes: neurofibromatosis type 1 suffer from particular skin pigmentation and risk

Gene	Location	Associated tumours
<i>BRCA1</i> <i>BRCA2</i>	17q 13q	Breast, ovary, colon, prostate Breast, ovary, pancreas, prostate
<i>p16 INK4A</i> <i>CDK4</i>	9p 6q	Melanoma, pancreas Melanoma, other tumours (rarely)
<i>hMLH1</i> <i>hMSH2</i> <i>hMSH6</i> <i>PMS1</i> <i>PMS2</i>	3p 2p 2p 2q 7p	Colorectal, endometrial, ovarian cancer Colorectal, endometrial, ovarian cancer Colorectal, endometrial, ovarian cancer Colorectal cancer, other tumours (rarely) Colorectal cancer, other tumours (rarely)
<i>HPC2</i>	17p	Prostate (rarely)

**Table 2.21** High-risk susceptibility genes and their chromosomal location. Inherited mutations in these genes are associated with some common cancers.

of pheochromocytoma, neurofibroma, gliomas and other tumours, while type 2 patients develop schwannomas and some other brain tumours [4]. Individuals afflicted with adenomatous polyposis, which is attributable to alterations in the *APC* gene, suffer from multiple premalignant lesions in the colon [5] (*Multistage carcinogenesis*, p84). In some, but not all such instances, the genes in question are also involved in sporadic cancers. Although the functions of these genes are not completely characterized, many appear to be involved either in key cellular processes such as control of the cell cycle, programmed cell death, or in repair and/or detection of DNA damage. In the rarer inherited cancer syndromes for which lifetime risks are very high, usually there are recognizable phenotypic features which make the syndrome easy to identify clinically, and a single genetic defect accounts for the majority of occurrences (Table 2.20). Other genes are associated with more common cancers, where there is a predominant type of cancer without other distinguishing clinical characteristics (Table 2.21). For some such genes, the actual genetic defect is not known but convincing evidence for a chromosomal localization has been reported. It should be noted that such distinction between the rarer inherited cancer syndromes and more common cancers is sometimes arbitrary.

## Prevalence, risks and impact of inherited cancer

The lifetime risks of cancer due to mutations in cancer predisposition genes can be very high; a woman who carries a mutated *BRCA1* gene has a lifetime risk of approximately 70% of developing either breast or ovarian cancer, compared with women lacking such mutations [6]. For some of the rare syndromes, risks of cancer can be even higher. Nonetheless, mutations in cancer predisposition genes are relatively unusual, ranging from 1/100,000 for very rare diseases such as Cowden syndrome, to 1/10,000 for germline *p53* gene mutations involved in Li-Fraumeni syndrome to 1/1,000 for genes like *BRCA1* and *MLH1* (involved in DNA mismatch repair). However, in some populations which have arisen from a relatively small number of founders, expanded rapidly and remained genetically isolated, these genes can achieve higher frequencies and therefore account for a larger fraction of cancers. For example, in the Jewish population, two specific mutations (one in *BRCA1*, one in *BRCA2*) are present. One in a hundred Jewish individuals carry one of these two mutations and they may account for as much as 40% of all ovarian cancer cases and 20% of all breast cancer cases diagnosed under age 40 in this population. Identification of genetically susceptible indi-

viduals, confirmation of a gene defect and provision of appropriate clinical care has led to development of specialist familial cancer clinics within comprehensive cancer care centres. Families now regularly seen in such clinics include those with inherited cancer due to the relatively common *BRCA1* gene alterations (Figs. 2.68, 2.69) and those which have the syndrome of multiple endocrine neoplasia type II (MEN2) [7]. As genetic testing for mutations in cancer susceptibility genes becomes more widespread, especially with regard to common, later-onset types of cancer, there are an increasing number of ethical, legal, and social issues to consider [8] (Box: *Ethics in cancer*, p322). Much of the discussion centres on issues regarding genetic discrimination, that is, the denial of health or life insurance or a job, based on a person's genetically-determined risk of developing a serious disease. Even for cancers where direct gene testing is available, there are some difficulties in interpreting the results. While in many cases the sequence variants are clearly deleterious, since they can lead, for exam-

ple, to truncated or absent protein products, other variants which simply change one amino acid in a complex protein cannot be clearly associated with increased risk. When no defect in a particular cancer gene is found in a member of a high-risk family in which the inherited defect has not been identified, the risk of cancer may still be high due to an undiscovered mutation in the same or another gene. In contrast, if the gene defect responsible for the cancer in an affected family has been identified, any member of that family who is found not to carry this defect will simply face the overall population risk of the cancer, which, for example, may be very low for retinoblastoma but as high as 1 in 11 for breast cancer [9]. Even when an individual is identified to carry a known deleterious mutation with a high lifetime cancer risk, intervention strategies may be limited. The psychological and social consequences of genetic testing for later-onset diseases, including breast and colon cancer are under investigation. Family members found to carry a predisposing mutation may suffer from increased

anxiety and depression from this knowledge, and parents may experience guilt in having transmitted the mutation to their children. Even individuals who are found not to carry the mutation otherwise present in their families sometimes suffer from adverse psychological effects arising from having been spared the misfortune.

### Gene-environment interactions

Some recent information indicates that some environmental factors may pose a particular hazard to individuals who have inherited a very high risk of cancer. For example, risk of breast cancer in women who have *BRCA1* mutations is influenced by certain environmental factors, indicating that such tumours are subject to hormonal influence, as are sporadic breast cancers [10,11].

The role of genes known to confer high cancer risks cannot explain all the familial risk for the relevant cancers and it is likely that there are other loci which are involved but which individually do not give rise to detectable familial clustering. These loci will be difficult, if not impossible to detect using traditional

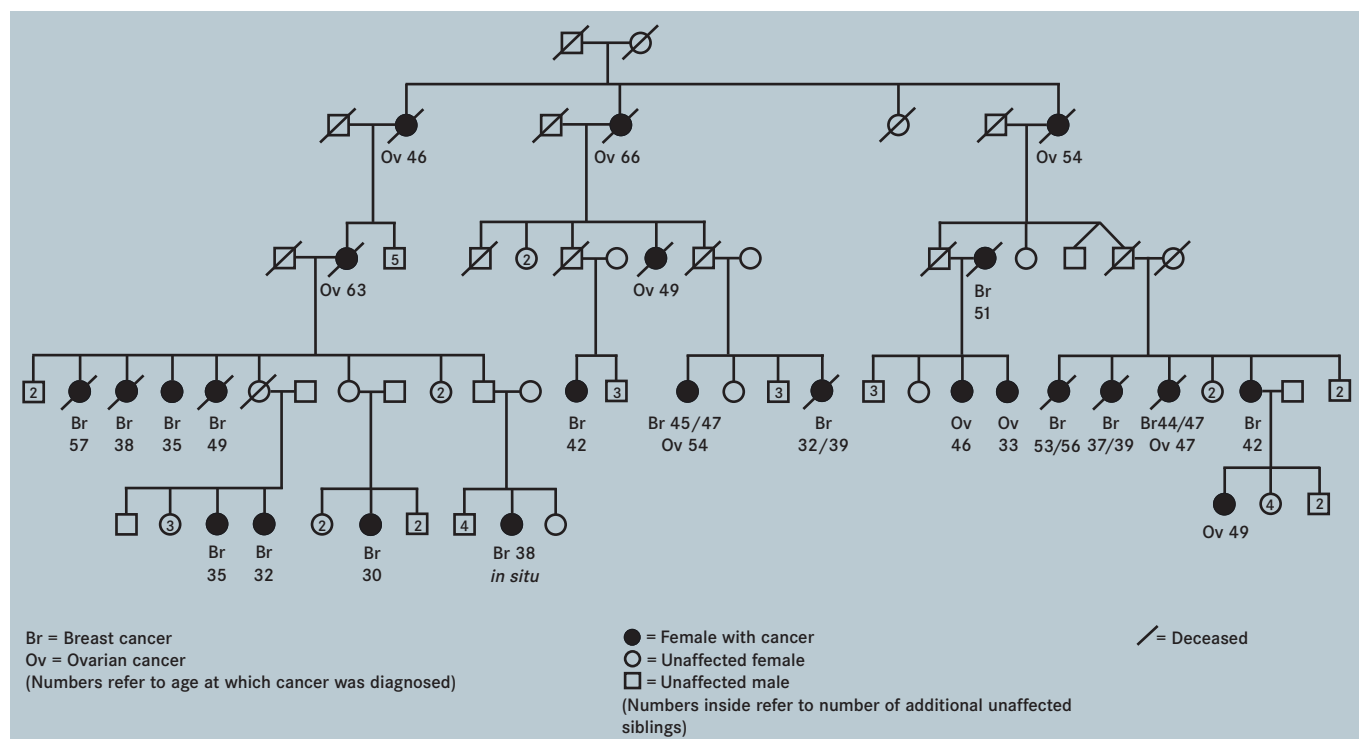

Fig. 2.68 Pedigree of a family with inherited cancers caused by a germline mutation in the *BRCA1* gene.

linkage studies in high-risk families. More likely, these loci, which may be associated with a two or three-fold increased risk of cancer (or even less), are more amenable to examination using either population-based or family-based case-control studies. One alternative approach is to focus on the fact that for any given environmental exposure, individual differences in susceptibility may have a genetic basis. Knowledge of the specific genetic polymorphism conferring this susceptibility should provide more power for the detection and characterization of the environmental risk factors through stratification of the sample according to the underlying genetic make-up. Likewise, there may be environmental factors that are associated with cancer (e.g. smoking and bladder cancer) in all individuals, but with a much stronger effect in individuals who have a reduced capacity to metabolize the relevant carcinogens (e.g. *N*-acetyltransferase-2, *NAT2* slow acetylators [7] or glutathione *S*-transferase, *GSTM1*-null individuals [12]). Two cytochrome P450 enzymes, CYP2D6 and CYP2A6, are associated with nicotine

metabolism [13,14]. Persons with a genetic deficiency in these enzymes smoke fewer cigarettes and can quit smoking more easily compared to individuals with normal activity of these enzymes. Drugs that inhibit the activity of these enzymes reduce a smoker's urge for cigarettes [15].

Genes relevant in this regard may be associated with a particular cancer or may be associated with basic cellular or physiological processes and include:

- genes coding for enzymes involved in the metabolism and detoxification of carcinogens including the cytochrome P450 [16] and glutathione *S*-transferase (GST) [17] families;
- genes involved in the repair of DNA damage;
- genes related to cell growth and differentiation or steroid hormone pathways;
- known high-risk genes, such as *p16<sup>INK4A</sup>*, *BRCA1* or *hMLH1*.

It is hoped that a more unified approach to cancer epidemiology and genetics will identify those combinations of genetic susceptibility and environmental exposures that lead to significant increases in risk at the individual

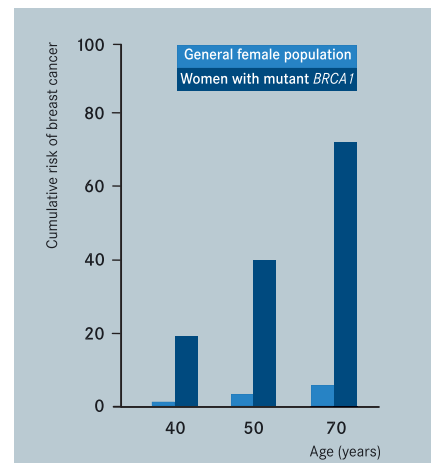

Fig. 2.69 Women carrying an inherited mutation in the *BRCA1* gene have a greatly increased risk of developing breast cancer.

and population level. This in turn could lead to reduction of the cancer burden by lifestyle modification and avoidance of specific exposures in genetically susceptible individuals.

## REFERENCES

1. Knudson AG, Jr. (1971) Mutation and cancer: statistical study of retinoblastoma. *Proc Natl Acad Sci USA*, 68: 820-823.
2. Steel M, Thompson A, Clayton J (1991), Genetic aspects of breast cancer. *Br Med Bull*, 47: 504-518.
3. Russo A, Zanna I, Tubiolo C, Migliavacca M, Bazan V, Latteri MA, Tomasino RM, Gebbia N (2000) Hereditary common cancers: molecular and clinical genetics. *Anticancer Res*, 20: 4841-4851.
4. Gutmann DH (2001) The neurofibromatoses: when less is more. *Hum Mol Genet*, 10: 747-755.
5. Fearhead NS, Britton MP, Bodmer WF (2001) The ABC of APC. *Hum Mol Genet*, 10: 721-733.
6. Eeles RA (1999) Screening for hereditary cancer and genetic testing, epitomized by breast cancer. *Eur J Cancer*, 35: 1954-1962.
7. Learoyd DL, Delbridge LW, Robinson BG (2000) Multiple endocrine neoplasia. *Aust N Z J Med*, 30: 675-682.
8. Evans JP, Skrzynia C, Burke W (2001) The complexities of predictive genetic testing. *BMJ*, 322: 1052-1056.
9. Nathanson KN, Wooster R, Weber BL (2001) Breast cancer genetics: what we know and what we need. *Nat Med*, 7: 552-556.
10. Rebbeck TR, Wang Y, Kantoff PW, Krithivas K, Neuhausen SL, Godwin AK, Daly MB, Narod SA, Brunet JS, Vesprini D, Garber JE, Lynch HT, Weber BL, Brown M (2001) Modification of BRCA1- and BRCA2-associated breast cancer risk by AIB1 genotype and reproductive history. *Cancer Res*, 61: 5420-5424.

11. King MC, Wieand S, Hale K, Lee M, Walsh T, Owens K, Tait J, Ford L, Dunn BK, Costantino J, Wickerham L, Wolmark N, Fisher B (2001) Tamoxifen and breast cancer incidence among women with inherited mutations in BRCA1 and BRCA2: National Surgical Adjuvant Breast and Bowel Project (NSABP-P1) Breast Cancer Prevention Trial. *JAMA*, 286: 2251-2256.
12. Brockton N, Little J, Sharp L, Cotton SC (2000) N-acetyltransferase polymorphisms and colorectal cancer: a HuGE review. *Am J Epidemiol*, 151: 846-861.
13. Nakajima M, Yamagishi S, Yamamoto H, Yamamoto T, Kuroiwa Y, Yokoi T (2000) Deficient cotinine formation from nicotine is attributed to the whole deletion of the CYP2A6 gene in humans. *Clin Pharmacol Ther*, 67: 57-69.
14. Bartsch H, Nair U, Risch A, Rojas M, Wikman H, Alexandrov K (2000) Genetic polymorphism of CYP genes, alone or in combination, as a risk modifier of tobacco-related cancers. *Cancer Epidemiol Biomarkers Prev*, 9: 3-28.
15. Sellers EM, Kaplan HL, Tyndale RF (2000) Inhibition of cytochrome P450 2A6 increases nicotine's oral bioavailability and decreases smoking. *Clin Pharmacol Ther*, 68: 35-43.
16. Ingelman-Sundberg M (2001) Genetic susceptibility to adverse effects of drugs and environmental toxicants. The role of the CYP family of enzymes. *Mutat Res*, 482: 11-19.
17. Strange RC, Spiteri MA, Ramachandran S, Fryer AA (2001) Glutathione-S-transferase family of enzymes. *Mutat Res*, 482: 21-26.

## WEBSITES

- UICC Familial Cancer and Prevention Project:  
<http://www.uicc.org/programmes/epid/familial.shtml>  
 GeneClinics, a clinical information resource:  
<http://www.geneclinics.org/>



# REPRODUCTIVE FACTORS AND HORMONES

## SUMMARY

- > Female sex steroid hormone metabolism, reproductive factors and menopausal status affect the development of endometrial, ovarian and breast cancer.
- > Use of combined oral contraceptives accounts for a slight increase in risk of breast cancer, but is protective against ovarian and endometrial cancers.
- > Hormone replacement therapy is associated with increases in risk of breast and endometrial cancers, but may relieve other health problems associated with menopause.
- > Energy imbalance due to a Western lifestyle causes increased serum levels of insulin-like growth factor I (IGF-I) which is predictive of an elevated risk for prostate cancer.

There is overwhelming evidence that sex steroids (androgens, estrogens, progestogens) can have an important role in the development of human tumours, especially of the female reproductive organs (endometrium, ovary) and breast.

### Cancers of the breast, endometrium and ovary

For breast cancer, incidence rates rise more steeply with age before menopause than after, when ovarian synthesis of estrogens and progesterone ceases and ovarian androgen production gradually diminishes. Furthermore, breast cancer risk is increased in women who have early menarche, or who have late menopause, whereas an early age at first full-term pregnancy and high parity are associated with reduced risk of the three forms of cancer [1]. The rise in incidence rates of endometrial cancer also appears to flatten off at older age, but this change is related

less markedly to the menopausal transition than is the case with breast cancer. Ovarian cancer risk does not show strong relationships with menstrual history, but is clearly and inversely related to parity [2]. Obesity (related to various alterations in plasma levels of total and bioavailable sex steroids) is a strong risk factor for endometrial cancer, as well as for breast cancer in postmenopausal women. Circulating levels of sex steroids are regulated by a range of factors, including insulin and insulin-like growth factors (IGFs), which thus provide a possible link between many observations regarding excessive energy intake and increased risk of cancer (Box: *IGF-1 and cancer*, p79). Together, these observations suggest that alterations in endogenous sex steroid metabolism, and notably the ovarian synthesis of sex steroids, can be an important determinant of risk for each of the three forms of cancer in women.

Breast cancer risk is increased in postmenopausal women with a hyperandrogenic (excess of androgens) plasma hormone profile, characterized by increased plasma levels of testosterone and  $\Delta$ -4 androstenedione, reduced levels of sex hormone-binding globulin and increased levels of total estradiol, and bioavailable estradiol not bound to sex hormone-binding globulin [e.g. 3-5]. Similarly, postmenopausal women are at increased risk from endometrial cancer. The situation for breast cancer in premenopausal women is less clear [6,7].

#### Oral contraceptives

Oral contraceptives, in the form of estrogen-progestogen combinations, were introduced in the early 1960s, and rapidly found very widespread use in most developed countries. Over 200 million women are estimated to have used oral contraceptives since their introduction and about 60 million women are currently using them [8].

Preparations of oral contraceptives have undergone substantial changes over time,

including reductions in the potency and dosage of the estrogens, addition of different progestogens (progesterone analogues), and introduction (in 1983) of biphasic and triphasic pills that vary in the amounts of estrogen and progestogen throughout the month. A progestogen-only pill ("minipill") was first marketed in the USA in 1973, but has never been used widely. Sequential pills, with two weeks of estrogen alone followed by a combination of estrogen and progestogen for five days, were removed from the consumer market in the 1970s after concern about a possible association with endometrial cancer. There is a small increase in the risk of breast cancer in current and recent users of combined oral contraceptives containing both estrogen and progestogen [8]. This association, however, is unrelated to duration of use or type and dose of preparation and, 10 years after cessation of use, is no longer present (Fig. 2.71). The association of breast cancer with oral contraceptive use may be a result of detection bias, due to increased attention to the occurrence of breast tumours in women regularly visiting a physician for contraceptive prescriptions.

Risk of endometrial cancer is approximately halved in women using combination-type oral contraceptives, the reduction in risk being stronger the longer the contraceptives are used [8]. The reduction in risk persists for at least ten years



Fig. 2.70 Varieties of oral contraceptives. Use of the contraceptive pill reduces the risk of cancers of the ovary and endometrium, but is associated with a slightly increased risk of breast cancer.

after cessation of use. Interestingly, however, use of sequential oral contraceptives, containing progestogens only in the first five days of a cycle, is associated with an increased risk of endometrial cancer. For ovarian cancer, risk is reduced in women using combined oral contraceptives, the reduction being about 50% for women who have used the preparations for at least five years (Table 2.22). Again, this reduction in risk persists for at least 10-15 years after cessation of use. It has also been suggested that long-term use of oral contraceptives (more than five years) could be a cofactor that increases risk of cervical carcinoma in women who are infected with human papillomavirus [9].

### Postmenopausal hormone replacement therapy

Clinical use of estrogen to treat the symptoms of menopause (estrogen replacement therapy or hormone replacement therapy) began in the 1930s, and became widespread in the 1960s. Nowadays, up to 35% of menopausal women in the USA and many European countries have used replacement therapy at least for some period. The doses of oral estrogen prescribed decreased over the period 1975-83 and the use of injectable estrogens for estrogen replacement therapy has also diminished. On the other hand, the use of transdermally administered estrogens has increased progressively to about 15% of all estrogen replacement therapy prescriptions in some countries. In the 1960s, some clinicians, especially in Europe, started prescribing combined estrogen-progestogen therapy, primarily for better control of uterine bleeding. The tendency to prescribe combined estrogen-progestogen hormonal replacement therapy was strengthened when first epidemiological studies showed an increase in endometrial cancer risk in women using estrogens alone.

A small increase in breast cancer risk is correlated with longer duration of estrogen replacement therapy use (five years or more) in current and recent users [8]. The increase seems to cease several years after use has stopped. There appears to be no material difference in breast cancer risk between long-term users of all hor-

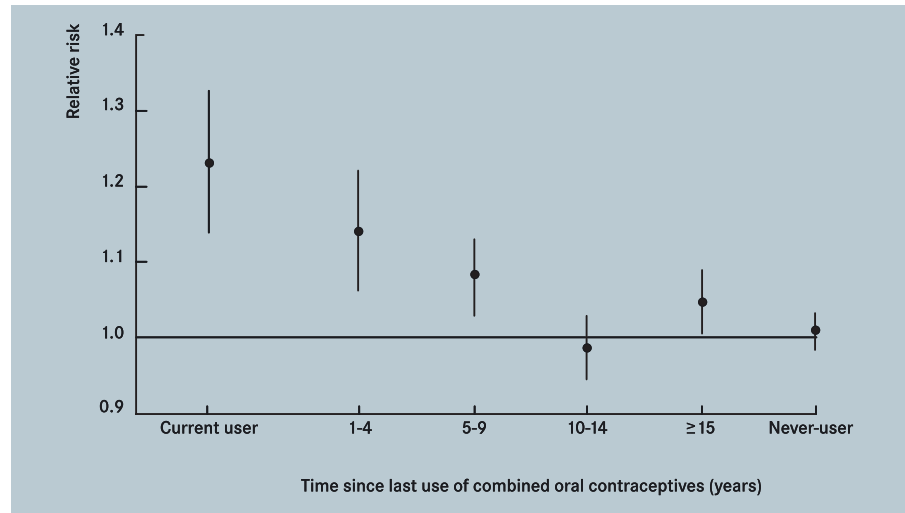

Fig. 2.71 Estimated risk of breast cancer by time since last use of combined oral contraceptives, relative to never-users. Data adjusted by age at diagnosis, parity, age at first birth and age at which risk of conception ceased. Vertical bars indicate 95% confidence interval.

more replacement therapy and users of estrogens alone. Nevertheless, one large cohort study and a large case-control study have provided strong evidence for a greater increase in breast cancer risk in women using hormone replacement therapy than in women using estrogens alone [10,11].

For endometrial cancer, there is an increase in risk among women using estrogen replacement therapy, the risk increasing further with longer duration of use [8]. In contrast, women using hormone replacement therapy have only a mild increase in risk compared to women who have never used any postmenopausal hormone replacement and this increase is much smaller than that of women who used estrogens alone. There seems to be no relationship between risk of ovarian cancer and postmenopausal estrogen use, while data on ovarian cancer risk in relation to hormone replacement therapy use are too scarce to evaluate.

### Prostate cancer

Normal growth and functioning of prostatic tissue is under the control of testosterone through conversion to dihydroxytestosterone [12]. Dihydroxytestosterone is bound to the androgen receptor, which

translocates the hormone to the nucleus. There have been conflicting findings as to whether patients with prostate cancer have higher levels of serum testosterone than disease-free controls. Diminution of testosterone production, either through estrogen administration, orchidectomy or treatment with luteinizing hormone-releasing hormone agonists, is used to manage disseminated prostate cancer.

### Mechanisms of tumorigenesis

#### Breast cancer

The role of endogenous hormones in breast cancer development suggests the “estrogen excess” hypothesis, which stipulates that risk depends directly on breast tissue exposure to estrogens. Estrogens increase breast cell proliferation and inhibit apoptosis *in vitro*, and in experimental animals cause increased rates of tumour development when estrogens are administered. Furthermore, this theory is consistent with epidemiological studies [4,15] showing an increase in breast cancer risk in postmenopausal women who have low circulating sex hormone-binding globulin and elevated total and bioavailable estradiol.

The “estrogen-plus-progestogen” hypothesis [15,16] postulates that, compared

## PHYTO-ESTROGENS AND CANCER PREVENTION

Plant foods contain phyto-estrogens, lignans and isoflavones, which are structurally similar to the mammalian estrogen, estradiol-17 $\beta$ . The significance of the structural similarity of the lignans and isoflavones to mammalian estrogens and possible cancer preventive effects were first promulgated in the early 1980s (Setchell KDR et al., *Am J Clin Nutr*, 40, 569, 1984; Adlercreutz H, *Gastroenterology*, 86, 761-6, 1984). The isoflavones are diphenols and include daidzein, equol and genistein, all of which have been shown to bind to  $\alpha$ - and especially  $\beta$ -estrogen receptors (Kuiper GG et al., *Endocrinology*, 138, 863-870, 1997). In common with many other weak estrogens, the isoflavones have been shown to be anti-estrogens, competing for estradiol at the receptor complex, yet failing to stimulate a full estrogenic response after binding to the nucleus. In animal models, inclusion of soy in the feed, a rich source, reduces mammary tumorigenicity. The lignans enterolactone and enterodiol are derived from microbial fermentation of secoisolariciresinol and matairesinol in foods, and excreted in urine. These have

also been shown to be weakly estrogenic and anti-estrogenic, and supplements have been shown to reduce tumorigenesis in a rodent model of breast cancer. However, proliferative effects of phytoestrogens on the human breast have also been suggested (reviewed in Bingham SA et al., *Br J Nutr*, 79, 393-406, 1998).

The cancers most closely linked to plant estrogens are the hormone-related carcinomas of breast and prostate, which appear to be less common in soy-consuming populations. However, in the most recent and largest prospective study of 34,759 women in Hiroshima and Nagasaki, there was no association between breast cancer risk and soya foods (Key TJ et al., *Br J Cancer*, 81, 1248-1256, 1999). Some recent epidemiological studies include biomarkers of intake, e.g. urine excretion of plant estrogens. One recent case-control study showed that tumour patients excreted significantly less equol and enterolactone in 72 hour urine collections than matched controls, but genistein was not measured (Ingram D et al., *Lancet*, 350, 990-992, 1997). A second study showed that overnight urine total isoflavonoid excretion, especially of glycitein, was significantly lower in cancer cases compared



Fig. 2.72 A Nigerian woman boiling milk from strained soya beans to make soy curd. This is becoming a substitute for a cheese traditionally made from more expensive cows' milk.

with controls (Zheng W et al., *Cancer Epidemiol Biomarkers Prev*, 8 35-40, 1999). Messina MJ et al. (*Nutr Cancer* 21, 113-131, 1994) reviewed the evidence relating to the impact of soy on cancers at sites other than the breast.

to an exposure to estrogens alone (as in postmenopausal women not using any exogenous hormones), risk of breast cancer is increased further in women who have elevated plasma and tissue levels of estrogens in combination with progestogens. This theory is supported by observations that postmenopausal women using estrogen-plus-progestogen preparations for hormone replacement therapy have a greater increase in breast cancer risk than women using estrogens alone [10,11]. In premenopausal women, the estrogen-plus-progestogen theory may explain why obesity is associated with a mild reduction in breast cancer risk [16], because obesity may cause chronic anovulation and decreases in luteal-phase progesterone levels.

### Endometrial cancer

Most observations relating endometrial cancer risk to endogenous and exogenous sex steroids, as well as to other risk factors (obesity, ovarian hyperandrogenism syndromes; see below) are explicable by the "unopposed estrogen" hypothesis [13,14]. This stipulates that risk is increased among women who have high plasma levels of bioavailable estrogens and low plasma progesterone, so that the effect of estrogens is insufficiently counterbalanced by that of progesterone. The hypothesis is supported by observations that proliferation of endometrial cells, a necessary condition for cells to accumulate genetic mutations and to expand clonally with selective growth advantage, occurs at greater rates during the follicu-

lar phase of the menstrual cycle (when the ovary produces estrogens but very little progesterone), than during the luteal phase (when the ovaries produce both estrogens and progesterone). Furthermore, there are frequent case reports of ovarian hyperandrogenism (polycystic ovary syndrome) in women developing endometrial cancer before the age of 40 and other studies showing an increased risk of endometrial cancer in polycystic ovary syndrome patients [13]. Polycystic ovary syndrome is a relatively frequent endocrine disorder, with an estimated prevalence of 4-8%, and in premenopausal women is associated with frequent anovulatory menstrual cycles and hence with impaired luteal-phase progesterone synthesis. Finally, the theory explains why

## IGF-1 AND CANCER

Insulin-like growth factors (IGFs) are a family of peptide hormones which have been found to reflect excess energy intake associated with the Western lifestyle and an increased risk of several hormonally-responsive tumours.

IGFs have direct effects on tumour development. IGF-1 has been found to be involved in the stimulation of cell proliferation and differentiation and suppression of apoptosis in organs such as the breast, prostate gland, colon and lung (Yu H et al., *J Natl Cancer Inst*, 92: 1472-1489, 2000). IGFs are overexpressed in certain cancers, and cancer cells with a strong tendency to metastasize have higher expression of IGFs. Many molecules known to be involved in cancer interact with IGFs, for example, the tumour suppressor p53, and the products of the *WT1* and *PTEN* genes, and also tumour viruses, e.g. HBV. Estrogens increase the cell-proliferative effects of IGF-1, induce IGF-1 expression and promote production of the IGF-1 receptor in breast cancer cells. Conversely, IGF-1 can strongly stimulate expression of the estrogen receptor in estrogen-receptor positive breast cancer cell lines (Yee D et al., *J Mammary Gland Biol Neoplasia*, 5: 107-15, 2000).

Blood and tissue concentrations of insulin, IGF-1 and IGF-binding proteins are intimately linked to energy balance and nutritional status (Kaaks R et al., *Proc Nutr Soc*, 60: 91-106, 2001). The primary factor influencing production of IGFs is growth hormone, whilst insulin appears to regulate levels according to nutritional conditions. Circulating IGFs in the blood are mainly bound to IGF-binding proteins (IGFBPs), in particular IGFBP-3, and are subject to elaborate systems of regulation. The bioactivity of IGF-1 is increased by insulin, which both promotes its synthesis and decreases production of certain IGF-binding proteins. Prolonged fasting or insulin-dependent diabetes mellitus (low plasma insulin levels) decrease the synthesis of IGF-1, whereas obesity and non-insulin dependent diabetes mellitus (high insulin levels) are characterized by reduced levels of IGFBPs-1 and -2, and increased levels of IGF-1. Brief periods of physical exercise in adults appear to increase levels of IGF-1 and IGFBP-1, although activities such as marathon running can decrease levels of IGF-1 for several days. IGF-1 and insulin are also directly involved in the regulation of circulating levels of sex steroids. This is achieved by the inhibition of synthesis of sex hormone-binding globulin, as well as stimulation of the production of sex steroids, especially androgens.

The role of IGFs may thus help to explain associations between energy imbalance and cancer risk discovered in epidemiological studies. Some cancers, including those of the endometrium and colon, have been linked to a history of type 2 diabetes, characterized by insulin resistance and chronic hyperinsulinaemia (excessive blood levels of insulin). Increased risk of several cancers, including those of the breast, prostate, endometrium and colon, is associated with excessive energy intake relative to expenditure (as a result of low physical activity or a diet rich in fats and carbohydrates).

Studies to date suggest a link between raised levels of IGF-1 and increased risk of breast, colon, prostate and lung cancers and childhood leukaemia, and a decreased risk associated with high levels of another IGF binding protein, IGFBP-3 (Yu H et al., *J Natl Cancer Inst*, 92: 1472-1489, 2000).

Further research is necessary to determine the influences of lifestyle factors on IGF levels and how these interact with genetic susceptibility. Such information could be used in the development and targeting of intervention programmes to prevent and control cancer.

endometrial cancer risk is increased in women taking high-estrogen/low-progestogen oral contraceptives or estrogen replacement medication without progestogens, whereas combination-type oral contraceptives containing estrogens plus progestogens protect against endometrial cancer, and hormonal replacement therapy with estrogens plus progestogens causes only a weak increase risk.

### *Ovarian cancer*

Ovarian cancer may develop in two stages. In the first stage, ovarian surface epithelium is entrapped into the stroma in

the form of inclusion cysts, that are believed to form as a result of repeated damage and remodelling of the ovarian epithelial surface induced by regular ovulations [16]. In the second stage, the inclusion cysts gradually transform to tumour cells, under the influence of hormonal factors. One hormonal factor strongly implicated is excessive stimulation by luteinizing hormone [2] which may act either directly, through the activation of luteinizing hormone-responsive genes, or indirectly, through over-stimulation of ovarian production of androgens. There is at least one study showing an increased ovarian cancer risk in women with poly-

cystic ovary syndrome, who generally have increased pituitary luteinizing hormone secretion. Oral contraceptive use, pregnancies and lactation all cause a suppression of pituitary luteinizing hormone secretion, and are also related to reduced ovarian androgen production, especially in women with a tendency to become hyperandrogenic.

### *Prostate cancer*

Risk of prostate cancer may be increased in men with high intra-prostatic concentrations of dihydrotestosterone. Dihydrotestosterone is formed from testosterone in the prostate and binds and activates the

Indicator	Number of oral contraceptive users among		Relative risk (95% confidence interval)
	Ovarian cancer cases	Controls	
Age (years)			
< 45	48	221	0.6 (0.3-1.0)
45-54	30	92	0.5 (0.3-1.0)
55-64	2	11	0.6 (0.4-0.9)
Parity			
0	21	67	0.6 (0.4-0.8)
1	15	75	0.6 (0.4-0.9)
≥ 2	44	182	0.3 (0.1-1.4)

**Table 2.22** Estimated relative risk of ovarian cancer for women who have used oral contraceptives at any period in their lives, given for different ages and number of births. S. Franceschi et al. (1991) *Int J Cancer*, 49: 61-65.

androgen receptor with a four times higher affinity than testosterone [18]. One determinant of intra-prostatic dihydrotestosterone formation may be variation in the activity of intraprostatic (type II) 5- $\alpha$ -reductase (SRD5A2), that catalyses the testosterone-dihydrotestosterone conversion. Another possible determinant, which could provide a physiological link between prostate cancer risk and nutritional lifestyle factors, is an increase in circulating levels of bioavailable testosterone unbound to sex hormone binding globulin, that can freely diffuse into the prostatic cells. The androgen hypothesis originated from

observations that surgical or medical castration can often dramatically improve the clinical course of advanced metastatic prostate cancer patients. Furthermore, Japanese and Chinese migrants to the USA have lower incidence rates of prostate cancer than men of African or European ancestry, and at the same time have been found to have lower 5- $\alpha$ -reductase activity; there are positive associations of prostate cancer risk with specific genetic polymorphisms in the SRD5A2 gene. Finally, polymorphisms in the androgen receptor gene causing increased receptor transactivation have also been found associated with an

increase in prostate cancer risk [12,19]. On the basis of the above observations, one can predict an increase in prostate cancer risk in men with elevated blood levels of bioavailable testosterone, as well as with levels of androstenediol-glucuronide, a major breakdown product of dihydrotestosterone and a possible marker of intraprostatic androgen activity. These predictions, however, have received only very limited support from epidemiological studies [20]. There is little evidence as yet for any association between circulating estrogen levels and prostate cancer risk.



## REFERENCES

1. Kelsey JL, Gammon MD, John EM (1993) Reproductive factors and breast cancer. *Epidemiol Rev*, 15: 36-47.
2. Weiss NS, Cook LS, Farrow DC, Rosenblatt KA (1996) Ovarian cancer. In: Schottenfeld D, Fraumeni JF, eds, *Cancer Epidemiology and Prevention*, New York, Oxford University Press, 1040-1057.
3. Secreto G, Zumoff B (1994) Abnormal production of androgens in women with breast cancer. *Anticancer Res*, 14: 2113-2117.
4. Thomas HV, Reeves GK, Key TJ (1997) Endogenous estrogen and postmenopausal breast cancer: a quantitative review. *Cancer Causes Control*, 8: 922-928.
5. Thomas HV, Key TJ, Allen DS, Moore JW, Dowsett M, Fentiman IS, Wang DY (1997) A prospective study of endogenous serum hormone concentrations and breast cancer risk in postmenopausal women on the island of Guernsey. *Br J Cancer*, 76: 401-405.
6. Helzlsouer KJ, Alberg AJ, Bush TL, Longcope C, Gordon GB, Comstock GW (1994) A prospective study of endogenous hormones and breast cancer. *Cancer Detect Prev*, 18: 79-85.
7. Rosenberg CR, Pasternack BS, Shore RE, Koenig KL, Toniolo PG (1994) Premenopausal estradiol levels and the risk of breast cancer: a new method of controlling for day of the menstrual cycle. *Am J Epidemiol*, 140: 518-525.
8. IARC (1998) *Hormonal Contraception and Post-Menopausal Hormonal Therapy (IARC Monographs on the Evaluation of Carcinogenic Risks to Humans, Vol. 72)*, Lyon, IARC Press.
9. Moreno V, Bosch FX, Muñoz N, Meijer CJLM, Shah KV, Walboomers JMM, Herrero R, Franceschi S (2002) Effect of oral contraceptives on risk of cervical cancer in women with human papillomavirus infection: the IARC multi-centric case-control study. *Lancet*, 359: 1085-1092.
10. Ross RK, Paganini-Hill A, Wan PC, Pike MC (2000) Effect of hormone replacement therapy on breast cancer risk: estrogen versus estrogen plus progestin. *J Natl Cancer Inst*, 92: 328-332.
11. Schairer C, Lubin J, Troisi R, Sturgeon S, Brinton L, Hoover R (2000) Menopausal estrogen and estrogen-progestin replacement therapy and breast cancer risk. *JAMA*, 283: 485-491.
12. Bosland MC (2000) The role of steroid hormones in prostate carcinogenesis. *J Natl Cancer Inst Monogr*, 39-66.
13. Grady D, Ernster VL (1996) Endometrial cancer. In: Schottenfeld D, Fraumeni JF, eds, *Cancer Epidemiology and Prevention*, New York, Oxford University Press, 1058-1089.
14. Key TJ, Pike MC (1988) The dose-effect relationship between "unopposed" oestrogens and endometrial mitotic rate: its central role in explaining and predicting endometrial cancer risk. *Br J Cancer*, 57: 205-212.
15. Bernstein L, Ross RK (1993) Endogenous hormones and breast cancer risk. *Epidemiol Rev*, 15: 48-65.
16. Cramer DW, Welch WR (1983) Determinants of ovarian cancer risk. II. Inferences regarding pathogenesis. *J Natl Cancer Inst*, 71: 717-721.
17. Fathalla MF (1971) Incessant ovulation – a factor in ovarian neoplasia? *Lancet*, 2: 163.
18. Bosland MC (1996) Hormonal factors in carcinogenesis of the prostate and testis in humans and in animal models. *Prog Clin Biol Res*, 394: 309-352.
19. Ross RK, Pike MC, Coetzee GA, Reichardt JK, Yu MC, Feigelson H, Stanczyk FZ, Kolonel LN, Henderson BE (1998) Androgen metabolism and prostate cancer: establishing a model of genetic susceptibility. *Cancer Res*, 58: 4497-4504.
20. Eaton NE, Reeves GK, Appleby PN, Key TJ (1999) Endogenous sex hormones and prostate cancer: a quantitative review of prospective studies. *Br J Cancer*, 80: 930-934.

## WEBSITE

The Endocrine Society:  
<http://www.endo-society.org/about/index.cfm>